

FEFCO

CONVERTING EQUIPMENT TECHNICAL SPECIFICATIONS



Table of content

Foreword	4
Pre-feeding	13
Feeding	23
Printing	26
Screen Roll	85
Slotter/Scorer	92
Die Cutting	100
Folding	113
Stacking	128
Bundling	137
Breaking	141
Palletising	147
General	155
OEE (overall equipment effectiveness) performance	156
Test Forms for Converting Equipment	162
Converting Equipment Glossary	166

Foreword

The corrugated industry is acting in an environment where the requirements of customers are getting more and more strict and demanding.

Customers are requiring Zero Defects on all kind of quality specifications:

- Color to color register
- Color variation
- Folding accuracy (gap control and fishtailing)
- Tray length variation
- Scoring depth
- Glue accuracy
- Print to die cut register
- Others

These requirements can only be obtained by using the most appropriate paper and board, by training the operators to the highest level and using the best available practices in our industry.

The converting machines are playing a major role in obtaining the required quality level of the finished products and meeting customer demands.

This book on "Converting Equipment Technical Specifications" is meant to support all those in our industry who are involved in procuring converting machines, and doing acceptance testing during selection, commissioning, installation and guarantee phase.

These specifications are also useful for machine conditioning and continuous process improvement, for example before or after maintenance, quality checks etc.

As we are operating in a fast evolving environment, this book will in time be revised when necessary.

We are convinced that the specifications in this book will support our corrugated industry to act on a higher and more advanced level and will motivate machine suppliers to develop and deliver machines which are fulfilling customers' requirements on the quality level of finished products.

The "FEFCO Technical Specifications for Converting Equipment" are developed by Wilbert Streefland (Technology Coaching) in close collaboration with the members of the FEFCO Production Committee.

The FEFCO Production Committee

MACHINE ACCEPTANCE



The need for machine acceptance testing can best be explained by asking the following question:

How do you ensure that what is delivered conforms to what was agreed?

The starting point is to define quantitative, qualitative machine performance specifications. This book is addressed to both corrugated manufacturers and their machine suppliers. The outcome of machine acceptance testing is the confirmation of whether a machine meets pre-set targets or not.

Acceptance testing contributes to the turnkey supply of equipment.

The individual elements of the acceptance test procedures and process need to be defined.

The elements of the acceptance test should be quantitative and measurable.

The targets for the elements of the acceptance test are agreed by the customer and supplier and documented in the supply contract.

Disclaimer

Safety is important and needs to be checked. Safety standards should be in place according to local and international safety regulations.

Machine acceptance safety standards are not described in this document.

1. Introduction

This report provides information about machine acceptance testing:

- What is machine acceptance?
- Why carry out machine acceptance?
- How is it done?
- How do you agree targets?
- How is it specified in the contract?
- Cost justification

The need for machine acceptance testing can best be explained by asking the following question:

How do you ensure that what is delivered conforms with what was agreed?

The performance specification and outcome need to be quantitative and factual.

2. What is machine acceptance?

Machine acceptance is testing to see if equipment meets pre-set targets.

The set targets are measurable and quantitative.

The test methods used for measuring the targets are clear to the supplier and customer before signing a supply contract.

3. Why machine acceptance?

Machine acceptance based on measurable targets will avoid discussions during the supply process. It supports the turnkey supply of equipment.

Turnkey supply means that the equipment is ready for production after having successfully completed the acceptance test.

The acceptance test contains the elements that are key to the production process for which the machine is designed.

These elements need to be measurable and targets should be realistic in terms of what is possible for the technology used in the production equipment. This also applies to the performance needs of the product made by the production equipment.

4. How is it done?

The product made by the production equipment has individual performance criteria which can be described. Parts or key elements of the production equipment can also be described. Appendix 1 gives an overview of specifications for testing key elements of conversion equipment as used in the corrugated industry.

It is important that the individual elements of an acceptance test have quantitative and measurable targets.

Machine acceptance can be done during different phases of the machine lifecycle:

- during selection when looking for new equipment
- commissioning
- after installation
- close to the end of the guarantee period

An acceptance test is always done according to a predefined test procedure showing when, what and how an element of the acceptance test should be tested.

4.1 Selection

The acceptance tests can be used during the selection process of equipment.

Running tests during this phase will help selection of a machine that best meets requirements before discussing price.

The test results will also identify if set targets are realistic and necessary for the product to be manufactured.

The selection of test elements and their target performance level can be part of the supply contract.

4.2 Commissioning

The commissioning phase is the time when the machine is still at the machine supplier premises but is up and running.

During commissioning the acceptance test can be conducted for the elements agreed in the contract. A contract therefore not only describes what is purchased (the hardware) but also specifies how the hardware is expected to perform.

A specification used for describing an element for testing during machine acceptance only explains how the test is done and how the results are presented. It never defines the target level of the results. This is agreed in the contract.

The machine must pass all elements of the acceptance test before it is ready for shipment.

4.3 Installation

After installation of the machine at the customer's premises an acceptance test is conducted at the moment the machine supplier declares it ready for production. This means that targets set for all elements of the acceptance test procedure should have been met.

The machine needs to pass the acceptance test before the agreed date that the machine should be ready for production.

4.4 Guarantee

Production equipment should pass the acceptance test just after installation but it should be checked if this is still the case close to the guarantee end date. Even if the guarantee period is over this does not mean that the machine is not able to make the product within the agreed target.

The acceptance test will show if the machine is still performing within the agreed target.

5. How do you agree targets?

Some individual technical specifications provide recommendable targets that could be considered and are not binding.

Targets for the individual elements of a machine acceptance test are agreed between customer and supplier.

Over-specifying a machine will increase production cost. Under-specifying a machine results in a product that does not meet market requirements, unnecessary waste and damage to reputation.

Targets are best to be based on the results of acceptance tests done during the selection process.

Targets need to be realistic and achievable by the technology used. This also requires that the measuring methods used for determining the results of a test have sufficient clarity and accuracy to provide an unambiguous test result.

Step one of setting targets is to select elements of the acceptance test as listed in appendix one.

Step two is to agree what level is needed so that the product will meet customer demands.

Step three is to check if the equipment is able to meet these levels and if all parties agree on these levels.

Step four is to specify the test procedures and agreed targets in the supply contract.

6. How is it specified in the contract?

The following table is an example of what can be included in the supply contract. The contract only includes the elements agreed. The "Target" column specifies the agreed target. The "Result of testing" column shows the results of the acceptance test.

Process part	Technical Specification (TS) number	Name	Target	Result of testing
Pre-feeding	0101	Stops/1000 sheets		
	0102	Time between stops when running on auto mode		
	0103	Waste sheets		

7. Conclusion

Acceptance testing contributes to the turnkey supply of equipment.

The individual elements of the acceptance test procedures and process need to be defined.

The acceptance test elements need to be quantitative and measurable.

The target level for acceptance test elements are agreed by both parties and documented in the supply contract.

Rev#	Revised documents	Date
1.1	Added technical specifications to the list: TS0317, TS0318, TS0319, TS0320, TS0321, TS0322, TS0707, TS1102, TS1103, TS1202, TS1203	14/02/17
1.2	TS0702 (new), TS0703 (deleted)	

Appendix:

1. Technical specification list for key corrugated conversion equipment acceptance test elements

Appendix 1: List of technical specifications or key corrugated conversion equipment acceptance test elements

Process part	TS number	Name
Pre-feeding	0101	Stops/1000 sheets in relation to warp
	0102	Time between stops when running on auto mode
	0103	Waste sheets
Feeding	0201	Feed to first register PD/CPD variation
Printing	0301	TIR (screen roll, plate cylinder, impression cylinder)
	0302	Colour to colour register variation
	0303	Colour variation
	0304	Colour change during start-up
	0305	Ink consumption
	0306	Ink loss during colour change
	0307	Water addition during colour change
	0308	Ink system cleanliness after wash-up
	0309	Gap (barcode bar width variation)
	0310	Ghosting
	0311	Stripes in print, encoder test
	0312	Filling between dots
	0313	Print scuff (drying)
	0314	Gloss level
	0315	Stripes in print, bouncing test
	0316	Colour to colour register change during start-up
	0317	Start-up ink quantity
	0318	Idle ink consumption
	0319	Ink stability over time on the press Viscosity & pH
	0320	Dot stretch variation during one print repeat
0321	Defects in print	
0322	Dryer performance	
Screen roll	0401	Wet ink film thickness
	0402	Line count
	0403	Cell wall thickness
Slotter/ scorer	0501	Slot position relative to centre line
	0502	Slotting depth variation centre score
Die cutting	0601	Print to die cut register variation
	0602	Scoring depth variation
	0603	Tray length variation
	0604	Waste removal

Folding	0701	Glue consumption
	0702	Fishtailing and Gap variation
	0704	Folding torque in relation to depth
	0705	Number of stitches
	0706	Tape consumption
	0707	Waste inside folding section
Stacking	0801	Alignment
	0802	Stops/1000 sheets
	0803	Exact sheet count
Bundling	0901	Stops/100 bundles
Breaking	1001	Breaking force in relation to bundle height
	1002	Breaking cycle time
Palletizing	1101	Stops/pallet
	1102	Production speed in function of stacking pattern
	1103	Internal transport stacked product stability
General	1201	OEE (overall equipment effectiveness) performance
	1202	Weighted sound level pressure, ISO 11204
	1203	Maximum machine speed producing a good product

Addendum: Test conditions

The FEFCO specification for converting describe test procedures for acceptance criteria.

The targets for acceptance criteria are always agreed between the customer and the supplier.

Pre-testing may be required to establish targets. Pre-testing are tests being done on similar machines to the ones which are in the scope of supplies.

During acceptance tests, it is important to use skilled operators to conduct the tests.

The material and/or tool conditions used for a test that may need specification, depending on the acceptance criteria tested, are as follows:

- Board and paper grade
 - Board grades commonly used. Specify the flute types which will be tested. Each flute type can be linked to specific targets.
 - Paper grades: specifically for printing tests, the paper grade of the outer liner should be specified.
- Maximum warp allowed for board used.
- Stack conditions sent to the conversion line by the corrugator used in the plant according to FEFCO TS 0801.
- Ink commonly used in the plant:
 - manufacturer
 - type
 - ink viscosity
 - ink pH
 - ink solid content (density)
 - MSDS (material safety data sheet)
- Screen roll:
 - manufacturer
 - type: chrome or ceramic
 - surface pattern: hexagonal, square etc.
 - ink film thickness according to FEFCO conversion equipment TS 0401
 - line count according to FEFCO conversion equipment TS 0402
 - cell wall thickness according to FEFCO conversion equipment TS 0403
 - supplier quality document

- Doctor blade material
 - manufacturer
 - steel, plastic, etc.
 - bevel type
 - angle
- Varnish (for gloss)
 - manufacturer
 - type
 - viscosity
 - pH
 - solid content (density)
 - MSDS (material safety data sheet)
- Print plate as supplied by the repro house used by the plant:
 - polymer manufacturer
 - polymer type
 - hardness
 - thickness
 - use of foam backing material
 - thickness of foam backing material
 - mounting tape
 - thickness of mounting foil
 - mounting system
- Cutting die as supplied by the die manufacturer used by the plant:
 - manufacturer
 - ruler height
 - rubber type
 - rubber hardness
- Glue
 - PVA type
 - manufacturer
 - solid content (density)
 - MSDS (material safety data sheet)
- Score profile
 - manufacturer
 - profile dimension drawing
- Climate conditions in the production hall
 - humidity
 - temperature

It is recommended to carry out tests using the given test conditions in order to agree upon and set realistic targets that can be included in a contract.

WIN-WIN FOR THE WHOLE SUPPLY CHAIN



Pre-feeding



Document#	Name
0101 V1.0	Stops/1,000 sheets in relation to warp
0102 V1.0	Time between stops when running auto
0103 V1.0	Waste sheets

Pre-feeding

Stops/1,000 sheets

1. Subject

The specifying and measuring of stops/1,000 sheets when pre-feeding sheets to conversion equipment as used in the corrugated packaging industry.

2. Application area

This specification can be used for the pre-feeding of corrugated sheets in the following areas:

- printing offline
- printing and rotary die cutting
- printing and flatbed die cutting
- offline flatbed die cutting
- printing, slotting, scoring and folding as part of the flexo folding gluing process.

3. Definition

The units used for measuring stops/1,000 sheets in relation to warp are:

- number of stops/1,000 sheets
- time in seconds per stop
- percentage stop time of the total available production time.

Stops are defined as disruptions in production caused by pre-feeding which results in a deviation from the set machine running speed.

4. Test method

The pre-feeder is running in auto mode (without operator interference!).

The sheets running through the machine are detected using a sensor. Every sheet is counted and when detected the time from start is recorded.

The following is calculated from the collected data:

- time between detecting sheets
- the speed of the machine at the time of the sheet passing through.

The test can be conducted during the standard production of a large order, preferably >5,000 sheets.

The number of stops are counted during the conversion of the board. For each stop the reasoning is logged. e.g. the evacuation of an empty pallet or removal of damaged sheets.

It is important that the pre-feeder does not cause production stops.

The following is calculated from the collected data:

- percentage downtime
- stops/1,000 sheets

Equation for calculating percentage downtime:

$$\% \text{ downtime} = \frac{\text{stop time}}{\text{production time} + \text{stop time}} * 100\%$$

Equation for calculating stops/1000 sheets:

$$\text{stops/1000sht} = \frac{\text{number of stops} * 1000}{\text{number of sheets}}$$

Tests should be conducted using:

- different board grades
- different sheet sizes.

Test results are influenced by:

- board grade (flute type: B, C, BC, E, BE etc.)
- board size
- warp of sheets
- pre-feeder performance.

Warp measuring

Warp is measured before the pre-feeder test to ensure that board does not exceed the warp target.

The following image shows how warp is measured.

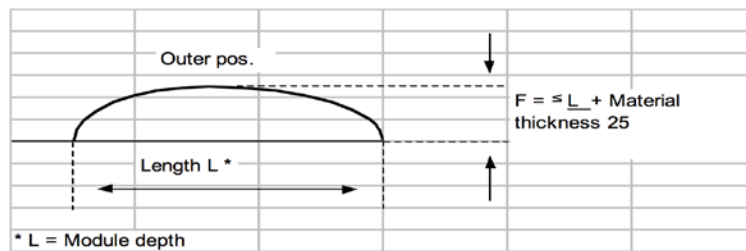

Warp is calculated using the following equation: $F = 0.02 \times L + \text{material thickness}$

A different option is to calculate the radius of a circle of which the warped board is a segment. The image illustrates how this is done.

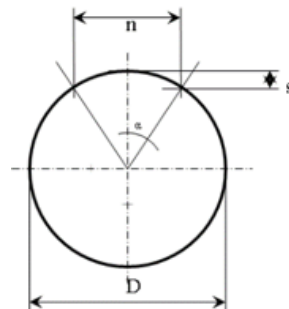

The equation for calculating the warp diameter is:

$$D = \frac{n^2 + 4 * s^2}{4 * s}$$

Board with no warp has an infinite diameter.

The radius (0.5 * diameter) is used to express warp.

The warp radius target is a radius of > 6,260 mm.

5. Results reporting

The following graphs show the results of a simulated run of 1,000 sheets using a sensor detecting every sheet passing through the machine.

Tests should be preferably done with 5,000 sheets.

For the example the total production time used producing 1,000 sheets is: 958.8 seconds.

The collected data is shown in graphs.

Sheet detection versus time graph:

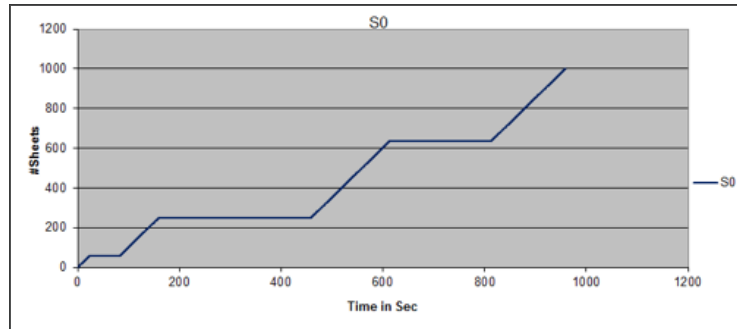

The three horizontal periods over time indicate the time when no sheets were detected.

Sheet speed graph:

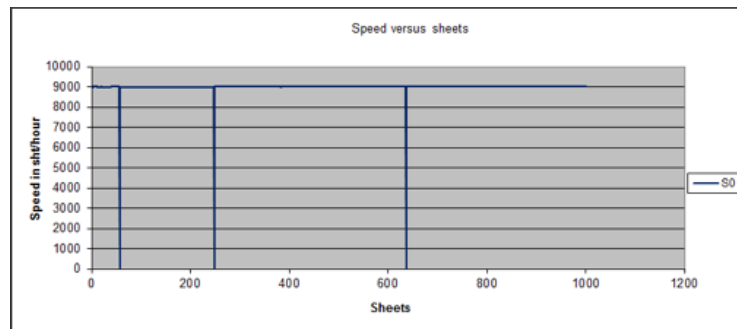

There are three interruptions in the speed graph.

Sheet interval time graph:

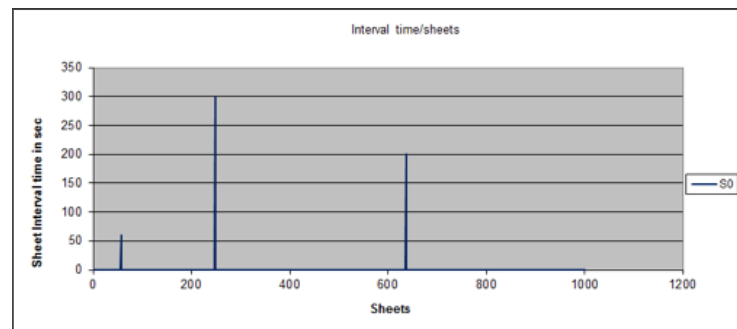

The graph shows three relatively large intervals between sheets:

- 60 seconds
- 300 seconds
- 200 seconds

Using the equation for percentage downtime:

Percentage downtime for the example is: $100 * 560/958.8 = 58\%$

Using the equation for stops/1000 sheets:

Stops/1000 sheets for the example is three.

6. Target

Target levels are always agreed between customer and supplier.

The target speed for running the test is 90% of the maximum machine speed.

The targets for the pre-feeder using sheets with warp radius >6,260 m are:

- < 1 stop/1,000 sheets
- downtime < 3%

Pre-feeding

Time between stops when running auto

1. Subject

The specifying and measuring of time between stops when running auto when pre-feeding sheets to conversion equipment as used in the corrugated packaging industry.

2. Application area

This specification can be used for the pre-feeding of corrugated sheets in the following areas:

- printing offline
- printing and rotary die cutting
- printing and flatbed die cutting
- offline flatbed die cutting
- printing, slotting, scoring and folding as part of the flexo folding gluing process.

3. Definition

The unit used for time between stops when running auto is percentage uptime.

Time between stops is the production time between two detected stops. The target is to run continuously.

The number of converted sheets and machine speed is measured by positioning a sensor inside the machine recording sheets passing through the machine.

Every time a sheet is detected the sheet count and time from the start is recorded.

Equation for calculating percentage uptime:

4. Test method

The pre-feeder should be running in auto mode.

The sheets running through the machine are detected using a sensor. Every sheet is counted and when detected the time is recorded.

The following is calculated from the collected data:

- time between detecting sheets
- the speed of the machine at the time of the sheet passing through
- time between stops
- downtime.

The target is to run at least 1,800 seconds (30 min.) without a stop.

The test can be conducted during the standard production of a large order, preferably >5,000 sheets.

It is important that the pre-feeder does not cause production stops.

Tests should be conducted using:

- different board grades
- different sheets sizes.

Test results are influenced by:

- board grade (flute type: B, C, BC, E, BE etc.)
- board size
- warp of sheets (See standard 0101: Pre-feeding, stops/1,000 sheets in relation to warp)
- pre-feeder performance.

5. Results reporting

The following graphs show the results of a simulated run of 1,000 sheets using a sensor detecting every sheet passing through the machine.

Tests should be preferably done with 5,000 sheets.

For the example the total production time used to produce 1,000 sheets was: 958.8 seconds.

The collected data is shown in graphs.

Sheet detection versus time graph:

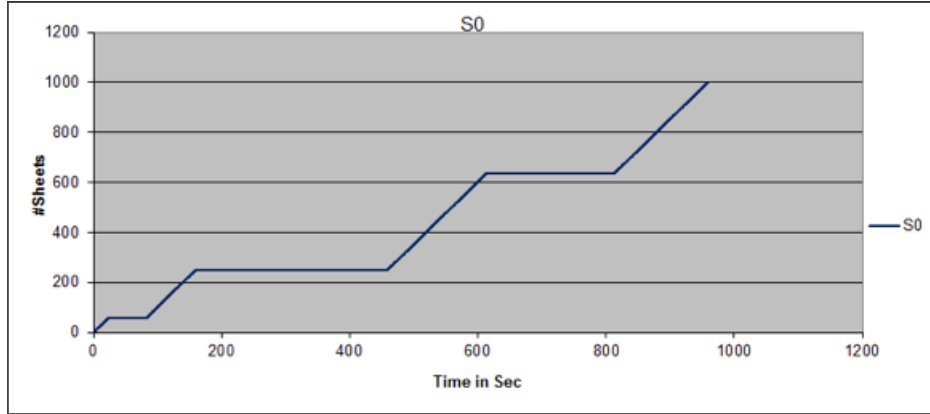

The four slanting vertical lines over time indicate when the machine is running.

Sheet speed graph:

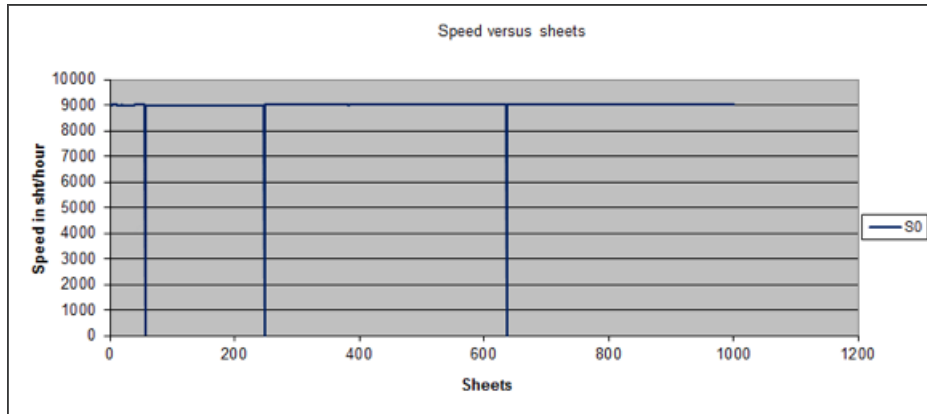

There are four periods running at 9,000 sheets/hour

Sheet interval time graph:

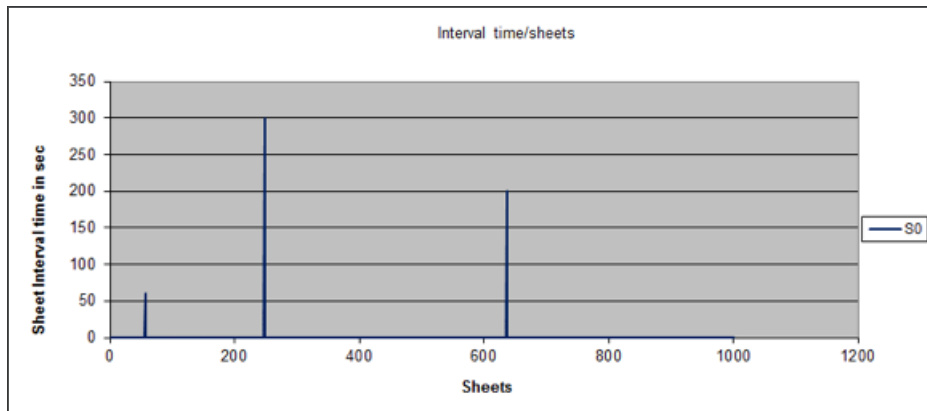

The graph shows four production periods and three stop periods - in total seven periods:

1. Production: 57 sheets 22.8 seconds
2. Stop: 60 seconds
3. Production: 191 sheets.....76.4 seconds
4. Stop:300 seconds
5. Production: 389 sheetsseconds
6. Stop:200 seconds
7. Production: 363 sheets 145.2 seconds

Production time: 400 seconds

Stop time: 560 seconds

Percentage uptime = $100\% * 400 / (400 + 560) = 42\%$

6. Target

Target levels are always agreed between customer and supplier.

The target speed for running the test is 90% of the maximum machine speed.

The target for the pre-feeder using sheets with warp radius of >6,260 m is:

- time between stops: > 1,800 seconds (30 minutes)
- uptime: > 97%

Pre-feeding

Waste sheets

1. Subject

The specifying and measuring of waste sheets when pre-feeding sheets to conversion equipment as used in the corrugated packaging industry.

2. Application area

This specification can be used for the pre-feeding of corrugated sheets in the following areas:

- printing offline
- printing and rotary die cutting
- printing and flatbed die cutting
- offline flatbed die cutting
- printing, slotting, scoring and folding as part of the flexo folding gluing process.

3. Definition

The unit used for waste sheets is percentage of waste sheets of total number of sheets supplied to the machine. 0% means no waste produced.

Waste sheets are all sheets removed at the pre-feeder. These sheets are not fed through the machine.

The waste sheets are standardized in relation to the total number of sheets used.

The total number of sheets is the waste sheets + converted sheets.

The equation for calculating percentage waste sheets is:

4. Test method

Tests should be preferably done with 5,000 sheets.

The number of converted sheets is measured by positioning a sensor inside the machine recording sheets passing through the machine.

Every time a sheet is detected the sheet count is recorded. This will provide a value for the number of sheets converted.

The waste sheets are manually counted or marked, for example with a digital marking pen as shown.



5. Results reporting

The converted sheets are counted by the sheet detection sensor positioned inside the machine.

The waste sheets, taken out at the pre-feeder, are counted manually or using a digital marking pen.

The percentage of waste sheets is calculated according to the above equation.

If, for example, 40 sheets are wasted and 5,020 sheets are converted, then the percentage of waste sheets is:
 $100\% * 40 / (5,020+40) = 0.8\%$

6. Target

Target levels are always agreed between customer and supplier.

The target speed for running the test is 90% of the maximum machine speed.

The target for the pre-feeder is:

- percentage waste sheets: < 0.5 % (5 sheets per 1,000 sheets). Excluding waste created by handling of stacks before the pre-feeder.

Feeding



Document#	Name
0201 V1.1	Feed to first register PD/CPD variation

Feeding

Feed to first register PD/CPD variation

1. Subject

The specifying and measuring of the **feed to first colour register and register variation** in print direction and/or cross production direction as used in the print and packaging industry.

2. Application area

This specification for feed to first register can be used in the following areas:

- sheet feeding: sheet to print
- web press: cross production direction only.

3. Definition

The unit used for measuring feed to first register is mm (millimetre).

Feed to first register registration error is the difference in the actual distance between the edge of the sheet and a printed element relative to the target position in production direction and/or cross production direction.

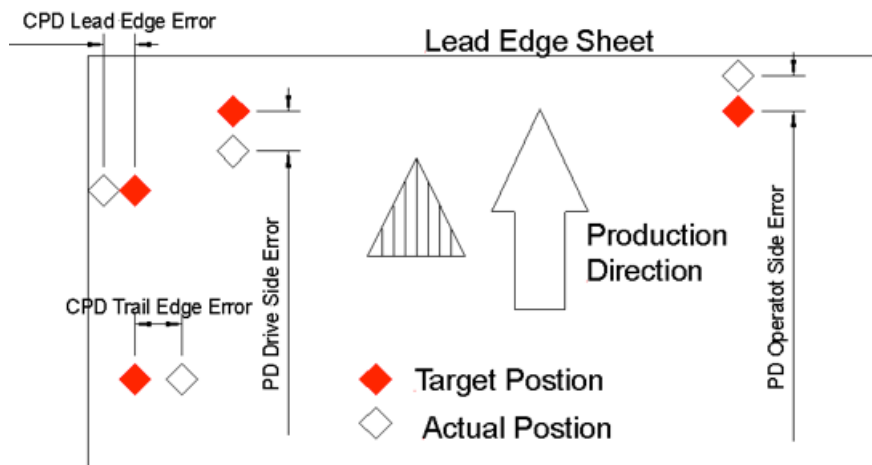

Above is an illustration of the feed to first colour register error. Feed to first colour register is one dimensional. Individual values can be measured for production direction (PD) and cross production direction (CPD). In the illustration the actual print is skewed.

The value for the feed to first colour registration error will be quantified separately as the **standard deviation** for all feed to first colour registration values.

4. Test method

A specially designed test form is used that holds elements in designated positions allowing the measurement of the feed to first register error visually or using image analysis. The following is a design example.



Element for visual measuring
Target is: long line on sheet edge



Elements for using image analysis
Positioned 15 mm from sheet edge

In the print the feed to first colour register is measured in two positions, preferably separated by at least 1 m. This should be done on at least 10 consecutively produced sheets.

In the production direction, the feed to first colour register is measured on the lead edge operator side and lead edge drive side. The difference between the average value on the operator side and the drive side is a value for skew. This skew value is standardised by dividing the cross production direction distance between the operator side and drive side measuring positions, resulting in a skew value in mm/m.

The feed to first colour register is in cross production direction measured on the operator or drive side lead edge and trail edge. The difference between the average value on the lead edge and the trail edge is a value for skew. This skew value is standardised by dividing it with the production direction distance between the lead edge and trail edge measuring positions, resulting in a skew value in mm/m.

The collected data can be corrected for the following systematic errors:

- offset register
- skew

The skew corrected lead edge to first colour variation can be calculated as a standard deviation after the feed to first colour operator side and drive side are offset by the average for the individual sides. This offsetting will take out the impact of the average board skew in the feeder.

5. Results reporting

The measured feed to first colour register data can be presented as shown in the following graph where all measured data on all sheets are shown in one graph:

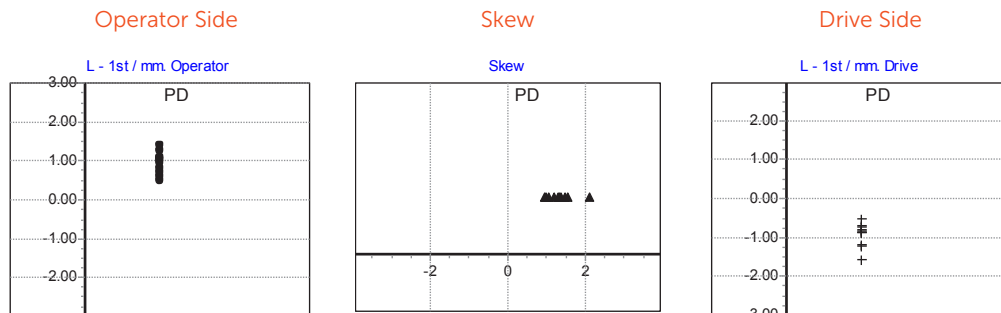

The following are examples of key values that can be quoted with the results:

- maximum lead edge to first colour value: 1.406 mm
- minimum lead edge to first colour value: -1.572 mm
- lead edge to first colour standard deviation: 1.001 mm
- lead edge to first colour average skew: -1.333 mm
- Skew corrected lead edge to first colour standard deviation: 0.294 mm

6. Target

Target levels are always agreed between customer and supplier.

The target speed for running the test is 90% of the maximum machine speed.

The test provides a value for the standard deviation of the measured values. Three times the standard deviation (3σ) of the test is < than the agreed range value. 3σ represents in this case 99.7% of the data population evaluated. Thus if 3σ is equal to the agreed feed to first register error, it means that 99.7 % of the measured data is within the agreed register error range e.g. ± 1 mm.

The following are typical feed to first colour standard deviation values and corresponding feed errors after correction for skew:

- low level: $\sigma < 0.50 \rightarrow$ feed to first register error: ± 1.50 mm
- medium level: $\sigma < 0.33 \rightarrow$ feed to first register error: ± 1.00 mm
- high level: $\sigma < 0.15 \rightarrow$ feed to first register error: ± 0.45 mm

References

Rev#	Revision	Date
1.1	Corrected text for recommended skew level Added skew correction before calculating standard deviation	25/4/16

Printing



Document#	Name
0301 V1.0	TIR (screen roll, plate cylinder, impression cylinder)
0302 V1.0	Colour to colour register variation
0303 V1.0	Colour variation
0304 V1.0	Colour change during start-up
0305 V1.1	Ink consumption
0306 V1.0	Ink loss during colour change
0307 V1.0	Water addition during colour change
0308 V1.1	Ink system cleanliness after wash-up
0309 V1.0	Gap (barcode bar width variation)
0310 V1.1	Ghosting
0311 V1.1	Stripes in print, encoder test
0312 V1.0	Filling between dots
0313 V1.0	Print scuff (drying)
0314 V1.0	Gloss level
0315 V1.0	Stripes in print, bouncing test
0316 V1.0	Colour to colour register change during start-up
0317 V1.0	Start-up ink quantity
0318 V1.0	Idle ink consumption
0319 V1.0	Ink stability over time on the press Viscosity & pH
0320 V1.0	Dot stretch variation during one print repeat
0321 V1.0	Defects in print
0322 V1.0	Dryer performance

Printing

Total indicated run-out (screen roll, plate cylinder, impression cylinder)

1. Subject

The specifying and measuring of total indicated run-out (TIR) for cylinders such as screen roll, impression cylinder, plate cylinder and die cut cylinder used in the print and packaging industry.

2. Application area

This specification for TIR can be used in the following areas:

- printing
- rotary die cutting
- calendaring
- embossing

The specification can be applied to rotary die cutting and the following print methods: flexo, offset, screen, gravure.

3. Definition

Total indicated run-out (or runout) is an inaccuracy in rotating mechanical systems, more specifically the body or shaft does not rotate exactly in line with the main axis. For example, a cylinder in a print unit having a high TIR results in a gap variation between the rotating cylinders. This will cause vibration as well as increased loads on the bearings.

Run-out is dynamic and cannot be compensated. Run-out has two main forms:

- radial run-out is caused by the tool or component being rotated off centre, i.e. the tool or component axis does not correspond with the main axis. Radial run-out will be the same all along the main axis.
- axial run-out is caused by the tool or component being at an angle to the axis. Axial run-out causes the tip of the tool (or shaft) to rotate off centre relative to the base. Axial run-out will vary according to how far from the base it is measured.

In addition, irregular run-out is the result of worn or rough bearings which can manifest itself as either axial or radial run-out.

Run-out will be present in any rotating system and, depending on the system, the different forms may either combine and increase total run-out, or cancel each other out, thus reducing total run-out. It is not possible to determine whether run-out is axial or radial at any point along a tool or shaft. Only by measuring along the axis can they be differentiated.

Absolute alignment is not possible, a degree of error will always be present.

The way to specify TIR in a mechanical drawing for a cylinder as used in a printing machine is shown in the following drawing. In this case the TIR is 0.015 mm:

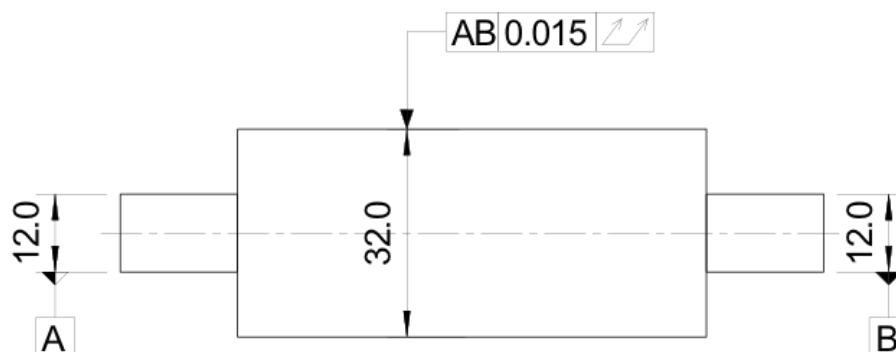

The TIR can also be shown as an isometric projection. The TIR is represented as two concentric cylinders where the gap between the concentric cylinders is 0.0075 mm when representing the previous drawing.

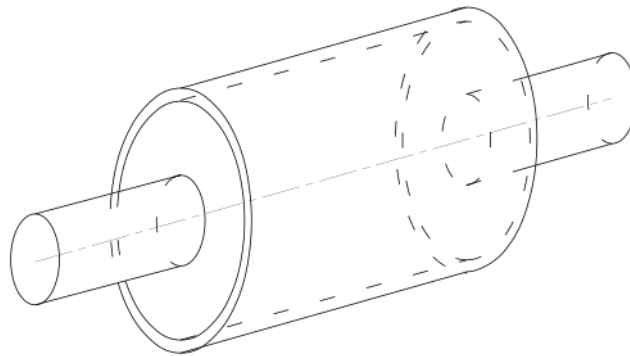

4. Test method



To measure TIR a (digital) dial indicator is used, preferably one with a resolution of 1 μm (0.001 mm) as shown in the image. The dial indicator can be connected to a computer for data collection.

The TIR is measured in three positions: operator side, centre (if possible) and drive side. Thus across the width of the roll body.

To do so the dial indicator is positioned perpendicular to the roll centre on the surface of the roll. The roll must be rotated at least one revolution for sufficient data collection.

5. Results reporting

The data collected with a digital dial indicator and recorded with a computer can be presented as shown in the following chart:

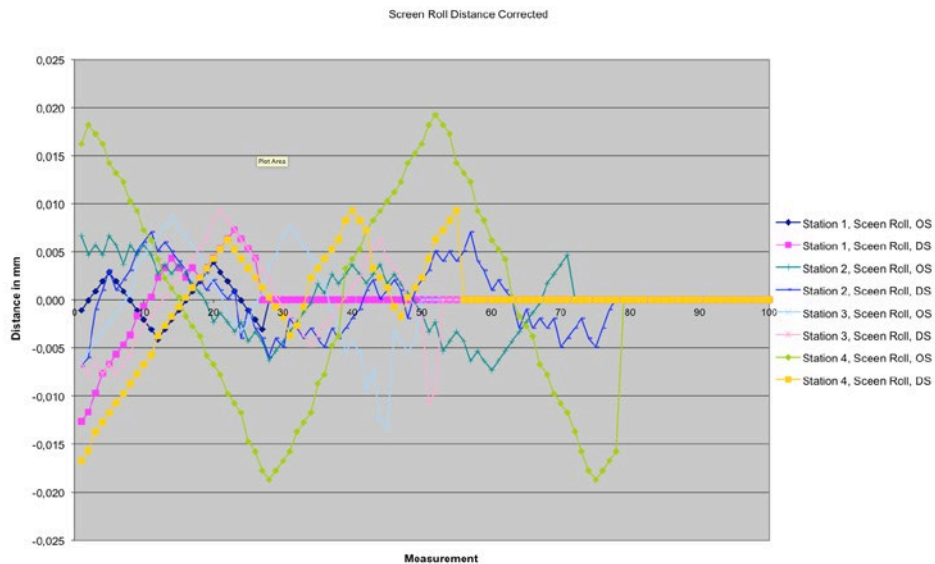

The data collected in one measuring position on the surface of a cylinder may be shaped like a sinus wave.

The TIR value is the difference between the maximum and the minimum value recorded when rotating the cylinder at least one revolution.

6. Target

Target levels are always agreed between customer and supplier.

The proposed maximum TIR values for cylinders as used in corrugated board conversion equipment are:

- screen roll: < 0.035 mm
- plate cylinder: < 0.050 mm (post-print)
- plate cylinder: < 0.010 mm (pre-print)*
- impression cylinder < 0.025 mm (post-print)
- central impression cylinder: < 0.010 mm (pre-print)*
- die cut cylinder: < 0.050 mm

**lower maximum TIR values for cylinders in pre-print machines are proposed due to the substrate not being compressible compared to corrugated board.*

References

NEN2210 Dutch shape and design definition for technical drawings

Printing

Colour to colour register variation

1. Subject

The specifying and measuring of register and register variation as used in the print and packaging industry.

2. Application area

This specification can be used in the following area:

- print: colour to colour register

The specification can be applied to any print method: flexo, offset, screen, gravure, digital, etc.

3. Definition

The unit used for measuring colour to colour register is mm (millimetre).

Colour to colour registration error is the distance between the printed positions of two separately printed elements that had the same position in the original.

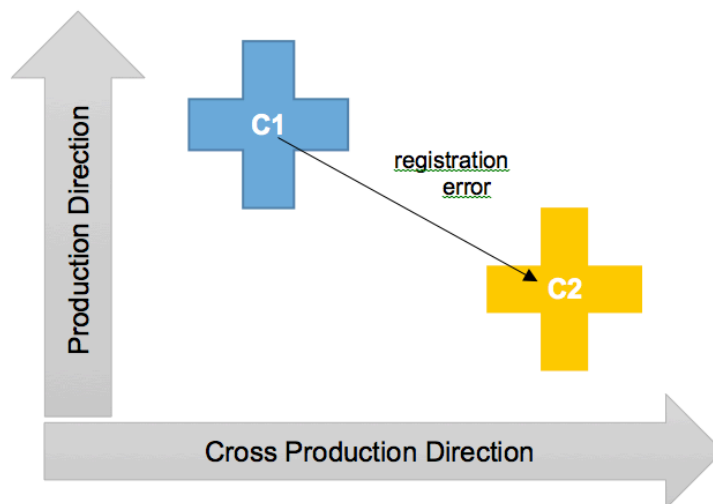

Above is an illustration of the registration error. Print register is two dimensional. A value needs to be measured for production direction (PD) and cross production direction (CPD).

The registration error is a distance. The following equation is used to calculate the registration error distance from the measured PD and CPD data:

$$R_{\text{error}} = \sqrt{PD_{\text{error}}^2 + CPD_{\text{error}}^2}$$

R_{error} = distance between two positions

PD_{error} = production direction distance between two positions

CPD_{error} = cross production direction distance between two positions

The value for the colour to colour registration error will be quantified separately as the standard deviation for all print direction values and cross print direction values. A value for the colour to colour registration spread can be computed by adding both values together in accordance with the general rule for adding errors:

$$\sigma_{total} = \sqrt{\sigma_{PD}^2 + \sigma_{CPD}^2}$$

σ_{total} = total statistical colour to colour registration error

σ_{PD} = standard deviation of the production direction colour to colour registration

σ_{CPD} = standard deviation of the cross production direction colour to colour registration

The following is an illustration of the register error between two colours:

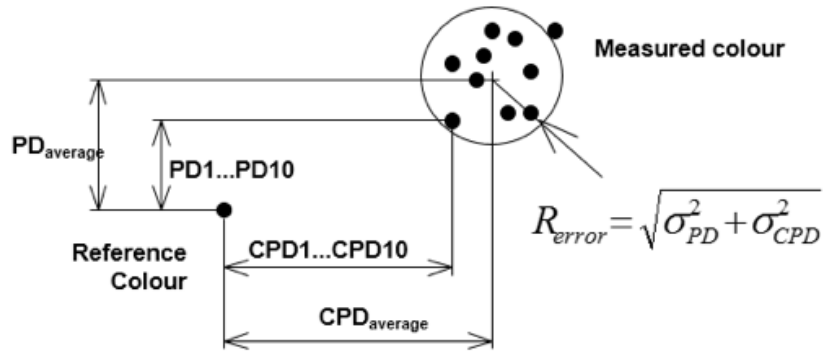

4. Test method

A specially designed test form as shown is used that holds elements in designated positions allowing the measurement of the register error visually or using image analysis. The following is a design example.

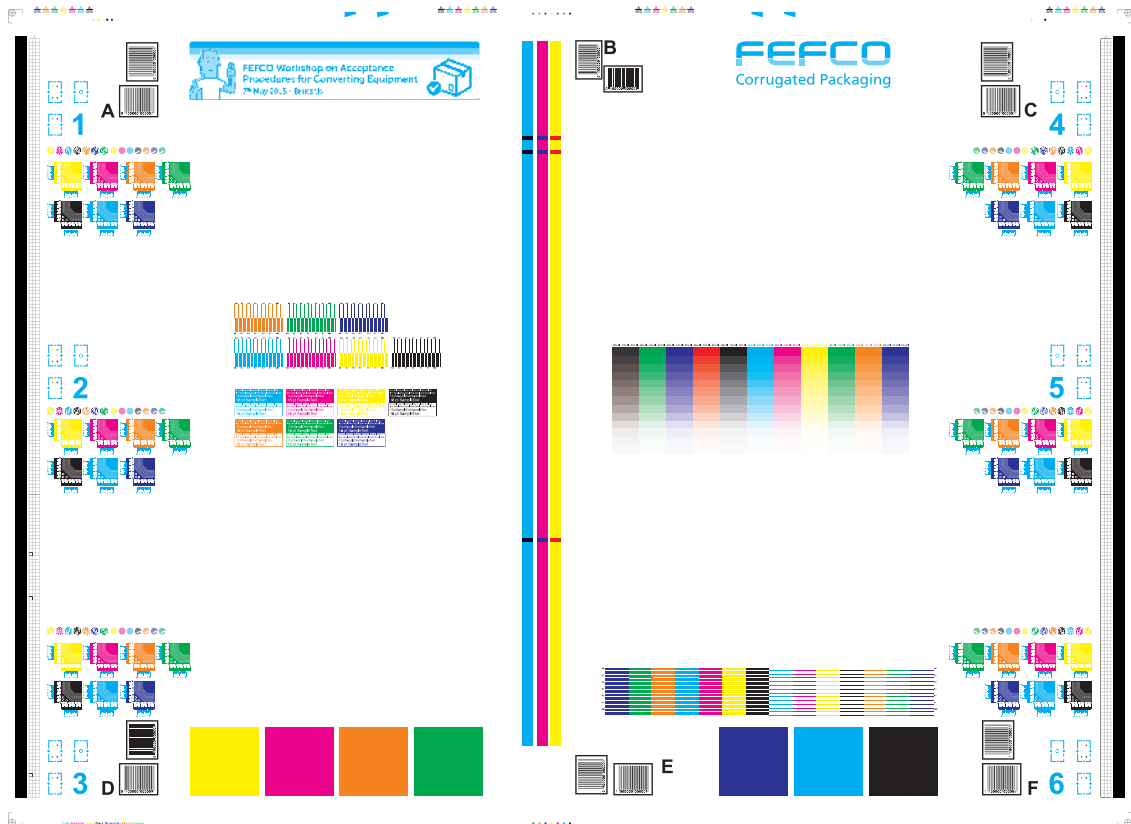

Example element for visual measuring

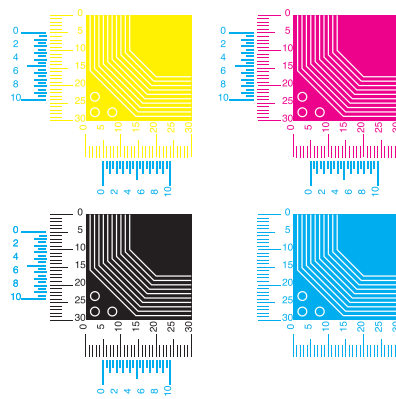

Example element for using image analysis

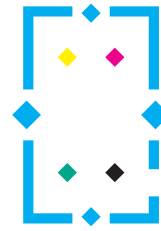

On the print the colour to colour register is measured in at least two positions, preferably in diagonal corners on the evaluated print. This should be carried out on at least 10 consecutively produced print repeats. A more accurate measurement will result if six positions are used. The register is measured between the reference (one of the printed colours) and all other colours printed.

The collected data can be corrected for the following systematic errors:

- offset register
- stretching of the print (mostly in print direction)
- skewing of the print (sometimes linked to the mounting of the print tool).

5. Results reporting

The measured register data can be presented as shown in the following graph, where all measured data on all sheets in all positions is shown in one graph:

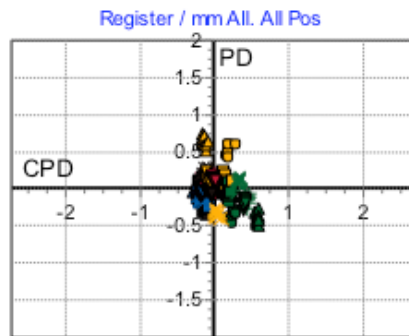

The standard deviation is calculated by direction (CPD and PD) and added up using the equation:

$$\sigma_{total} = \sqrt{\sigma_{PD}^2 + \sigma_{CPD}^2}$$

Results can also be shown (and calculated) by position:

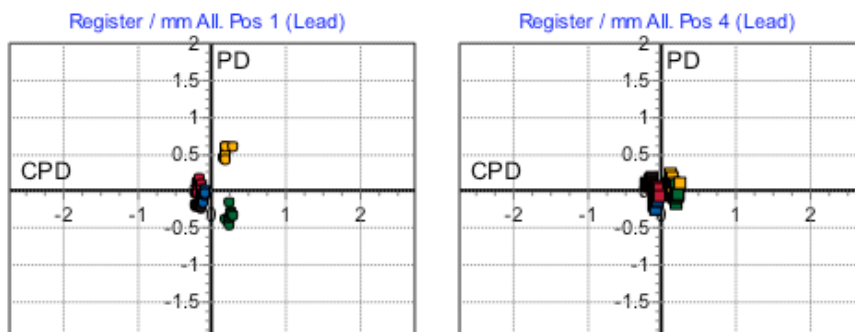

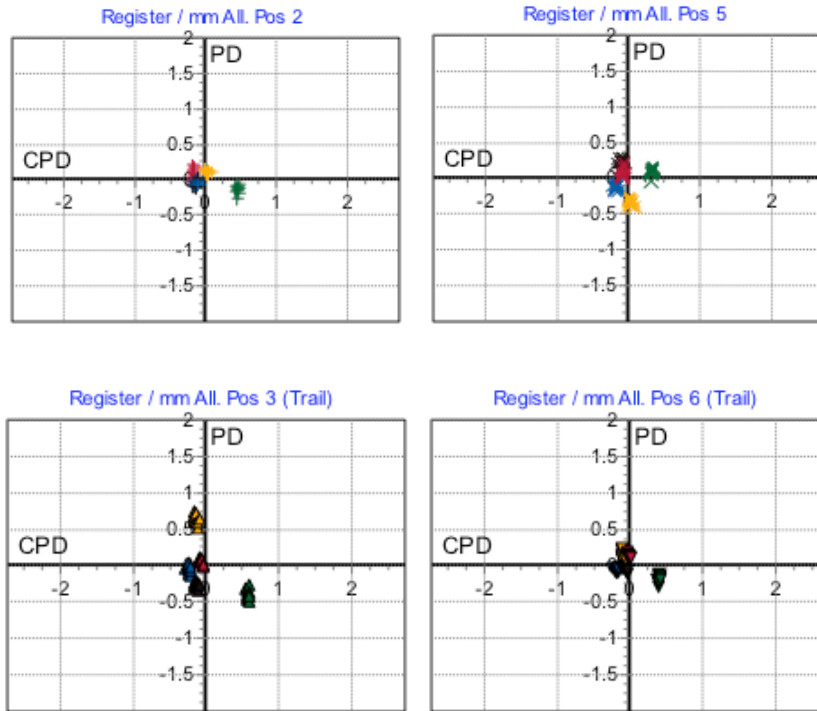

6. Target

Target levels are always agreed between customer and supplier. A range can be defined as the register error radius of a circle in which all measured register values are to be positioned.

The target speed for running the test is 90% of the maximum machine speed.

Depending on the print method used the data is corrected for non-machine errors such as offset, stretch and skew in case of machine acceptance.

The test provides a value for the standard deviation of the measured values. Three times the standard deviation (3σ) of the test is < than the agreed range (Radius) value. 3σ represents in this case 99.7% of the data population evaluated. Thus if 3σ is equal to the agreed register error radius it means that 99.7 % of the measured data is within the agreed register error radius.

The following image shows the relation between the test results and the agreed register error radius (0.75 mm) as a red circle:

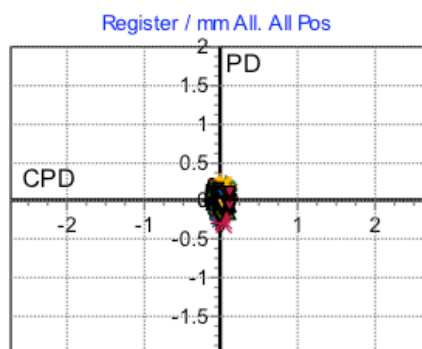

The following are typical register standard deviation values and corresponding register error radius for colour to colour register after correction for offset, stretch and skew:

- low level: $\sigma < 0.35 \rightarrow$ register error radius: 1.05 mm
- medium level: $\sigma < 0.25 \rightarrow$ register error radius: 0.75 mm
- high level: $\sigma < 0.15 \rightarrow$ register error radius: 0.45 mm

Printing

Colour variation

1. Subject

The specifying and measuring of colour and colour variation as used in the print and packaging industry during machine acceptance.

2. Application area

This specification can be used in the following area:

- print: colour variation

This specification can be applied to any print method: flexo, offset, screen, gravure, digital, etc.

3. Definition

The units used for measuring colour are the percentage (%) of light reflection of a surface at a given wavelength where the wavelength is expressed in nanometres (nm). The L, a, b values are calculated from the array of reflectance values for given wavelengths.

The a value represents an axis from green (-a) to red (+a). The b value represents an axis from blue (-b) to yellow (+b) and the L axis is where 0 is black and 100 is white.

The colour error is the linear distance between the printed colour represented as a point in a 3D colour space having L, a and b values and the target colour also positioned in the same 3D colour space with L, a and b values.

Colour variation is the colour error distribution between the individually measured colours and the target colour (average colour).

The target colour used for calculating the colour variation is defined as the average colour of all colour measurements used for measuring colour variation. In other words the average L value of all individual L value measurements of the measured colour, the average a value of all individual a value measurements of the measured colour and the average b value of all individual b value measurements of the measured colour.

The defined calculation method and equations to be used in this specification for colour variation are the least influenced by the printed colour. Equations are therefore used that do not correct measurements for visual perception of colour!

Using other colour equations and light sources will result in a greater difference in value for colour variation when using the same print station and a different colour.

4. Test method

The colour is measured using a calibrated spectrophotometer measuring colour in a wavelength range of at least 400 nm to 700 nm at intervals of 10 nm or lower.

The L, a, b values are calculated from the spectral reflectance data measured.

The calculation of the L, a, b values is done using the ASTM tables for light source: D65, angle 10° and standard observer 1964 [1].

For evaluating colour variation ΔE values are calculated from the average of all individual L, a, b values and the individual L, a, b values calculated from the measured spectral reflectance curve using the following equation:

All the ΔE values can be presented in a histogram.

$$\Delta E = \sqrt{(L_{avg} - L_m)^2 + (a_{avg} - a_m)^2 + (b_{avg} - b_m)^2}$$

L_{avg} = L average value

L_m = L measured value

a_{avg} = a average value

a_m = a measured value

b_{avg} = b average value

b_m = b measured value

The standard deviation of all ΔE values of all colour part of the data collected is a measure for the total colour variation in print. The standard deviation of all ΔE values by colour is a value for the colour variation by colour.

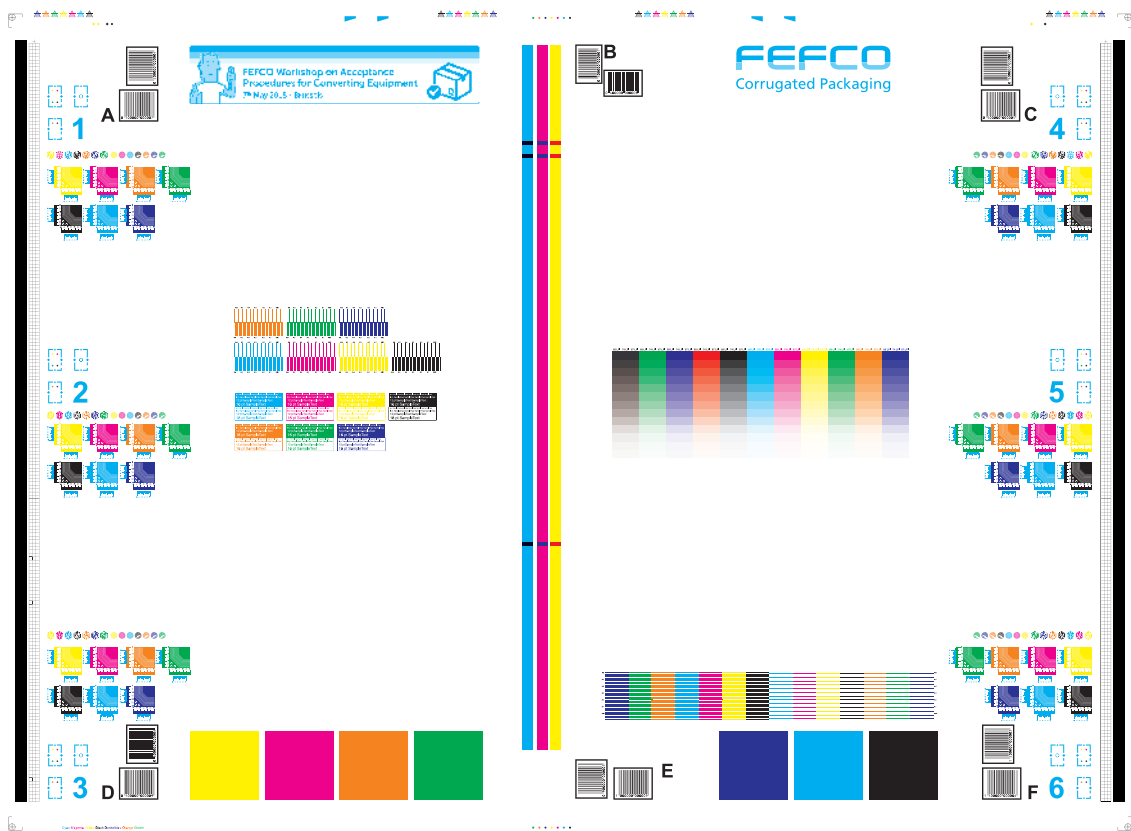

A specially designed test form as shown before is used that holds a single colour full tone area in designated positions allowing the measurement of the colour using a spectrophotometer, preferably with an aperture of 8 mm or larger. The element must have a full tone that is at least 10 by 10 mm for positioning the spectrophotometer. The following is a design example.

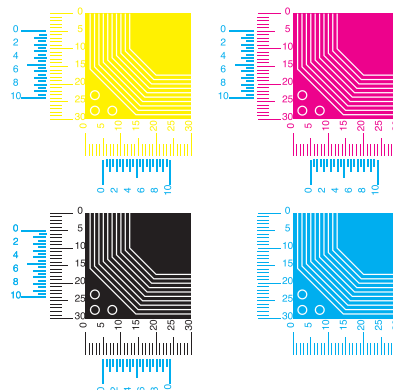

The individual colours (including paper colour) are measured in at least four positions, preferably in diagonal corners on the evaluated print. This should be carried out on at least 10 consecutively produced print repeats. A more accurate measurement will result if six positions are used.

5. Results reporting

The measured colour data can be presented as shown in the following graph where all measured data on all consecutive print repeats in all positions is shown in one histogram. Results are shown in histograms by colour, including paper:

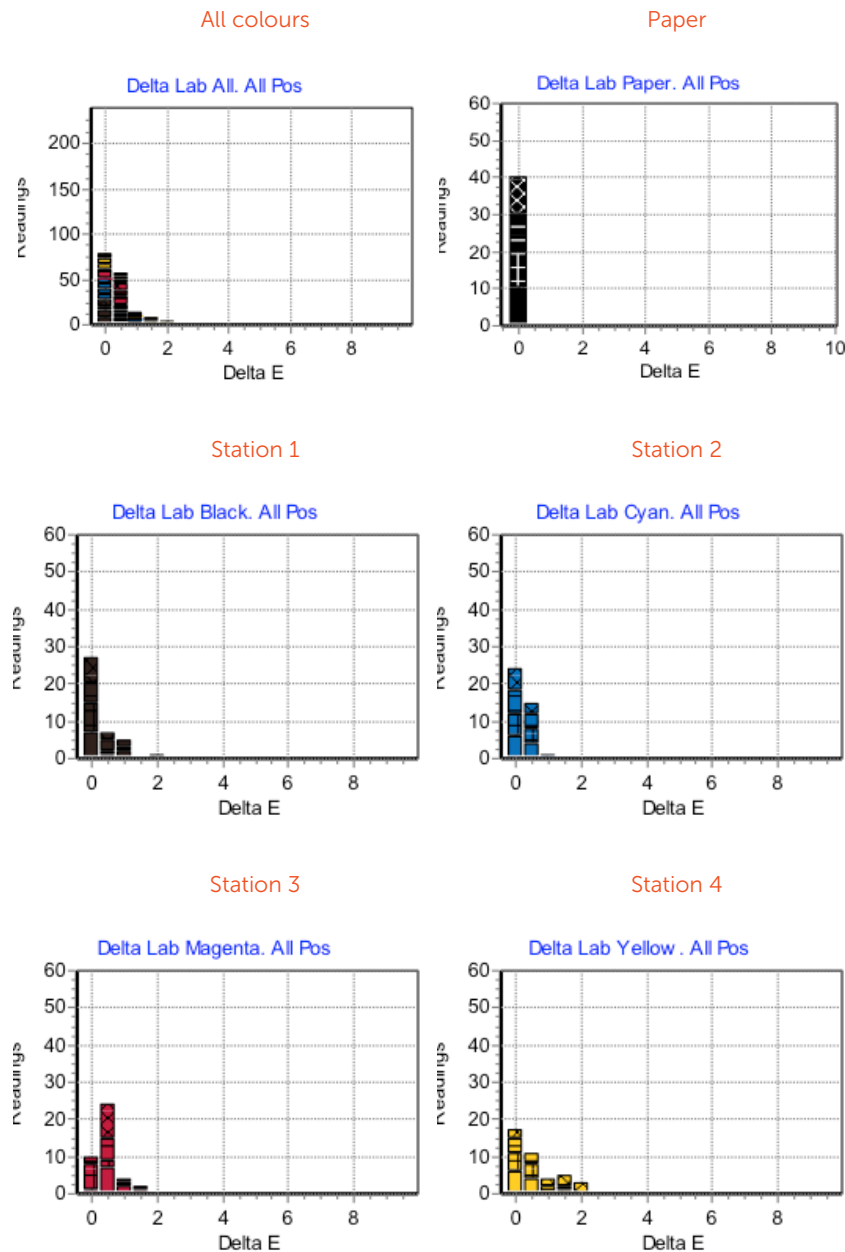

The following table is the representation of the colour variation standard deviation values calculated from the data presented in the graphs above:

Paper	0.10
All colours	0.46
Station 1, Black	0.45
Station 2, Cyan	0.26
Station 3, Magenta	0.35
Station 4, Yellow	0.62

6. Target

Target levels are always agreed between customer and supplier.

The target speed for running the test is 90% of the maximum machine speed.

Colour variation depends on the substrate printed on, production speed, ink and the ink film thickness transferred.

The proposed colour variation target independent of substrate, printed ink film thickness, print level or print process is: $\sigma \Delta E < 0.5$

The colour variation target of $\sigma \Delta E < 0.5$ means that there are two measurements of the same colour that differ $\Delta E \leq 3$ in the measured colour data population.

References

ASTM Designation: E 308 – 01, Standard Practice for Computing the Colors of Objects by Using the CIE System¹

Printing

Colour change during start-up

1. Subject

The specifying and measuring of colour change during start-up (short stops or feed interruption) as used in the print and packaging industry during machine acceptance.

2. Application area

This specification can be used in the following area:

- print: colour change during start-up.

The specification can be applied to any print method: flexo, offset, screen, gravure, digital, etc.

3. Definition

The unit used for measuring colour change during start-up is #sheets ($\Delta E > 2$).

The unit used for measuring colour is the percentage (%) of surface light reflection at a given wavelength, where the wavelength is expressed in nanometres (nm). The L, a, b values are calculated from the range of reflectance values for given wavelengths.

The a value represents an axis from green (-a) to red (+a). The b value represents an axis from blue (-b) to yellow (+b) and the L axis is where 0 is black and 100 is white.

The colour error is the linear distance between the printed colour represented as a point in a 3D colour space having L, a, b values and the target colour also positioned in the same 3D colour space with L, a, b values.

The colour change during start-up is the number of sheets which have greater target colour difference relative to the average colour printed, when the print process has stabilised.

When the print process has stabilised the average colour printed used for calculating the colour change during start-up is defined as the average colour of a series of consecutive print repeat colour measurements. For example, sheets 21 to 30 after starting production. This would mean taking the average L value of sheets 21 to 30 and the L value measurements of the measured colour, the average a value of sheets 21 to 30 and a value measurements of the measured colour and the average b value of sheets 21 to 30 and b value measurements of the measured colour.

The defined calculation method and equations to be used in this specification for colour variation are the least influenced by the printed colour. Equations are therefore used that do not correct measurements for visual perception of colour!

Using other colour equations and light sources will result in a greater different value for colour change during start-up when using the same print station and a different colour.

Colour change during start-up can be expressed as the number of sheets during start-up that have a colour difference larger than a target colour difference i.e. $\Delta E > 2$

4. Test method

The colour is measured using a calibrated spectrophotometer measuring colour in a wavelength range of at least 400 nm to 700 nm at intervals of 10 nm or lower.

The L, a, b values are calculated from the spectral reflectance data measured.

The calculation of the L, a, b values is done using the ASTM tables for light source: D65, angle 10° and standard observer 1964 [1].

For evaluating colour change during start-up ΔE values for sheets 1 to 30 are calculated from the average of all individual L, a, b values for sheets 21 to 30 and the individual L, a, b values calculated from the measured spectral reflectance curve using the following equation:

$$\Delta E = \sqrt{(L_{avg} - L_m)^2 + (a_{avg} - a_m)^2 + (b_{avg} - b_m)^2}$$

L_{avg} = L average value sheets 21 to 30

L_m = L measured value

a_{avg} = a average value sheets 21 to 30

a_m = a measured value

b_{avg} = b average value sheets 21 to 30

b_m = b measured value

The colour is measured in a full tone area using a spectrophotometer with an aperture of at least 8 mm.

The colour is measured on the first 30 consecutive print repeats in more or less the same position on every print repeat in a full tone area for each individual colour.

It is important that all print repeats are collected for this test after hitting the start button. The print repeats need to be numbered.

5. Results reporting

The measured colour data for colour change during start-up can be presented as in the following graph:

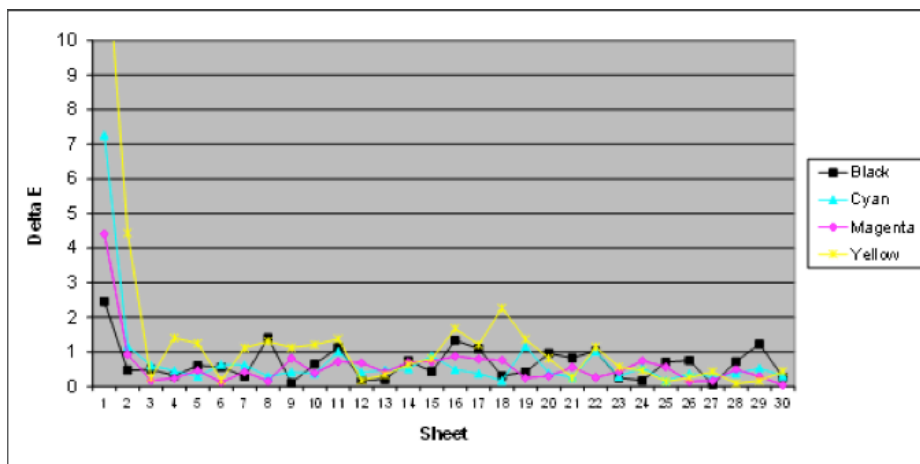

The colour change during start-up is quantified as the number of sheets that are above a given colour difference e.g.: $\Delta E > 2$

The following table shows the results from the data in the above graph in number of sheets by colour:

Test #	Speed	All colours	Black St 1	Cyan St 2	Magenta St 3	Yellow St 4
01	12,000	3	1	1	1	3

6. Target

Target levels are always agreed between customer and supplier.

The target speed for running the test is 90% of the maximum machine speed.

Colour change during start-up depends on the substrate printed on, production speed, ink and the ink film thickness transferred.

The proposed colour change target during start-up independent of substrate, printed ink film thickness, print level or print process is < 2 sheets.

References

ASTM Designation: E 308 – 01, Standard Practice for Computing the Colors of Objects by Using the CIE System1

Printing

Ink consumption

1. Subject

The specifying and measuring of **ink consumption** as used in the print and packaging industry during machine acceptance.

2. Application area

This specification can be used in the following area:

- print: ink consumption/ink transfer.

The specification can be applied to the flexo, gravure and digital print methods.

3. Definition

The units used for measuring ink consumption are:

- ink consumption: g/m²
- ink transfer: μm (micro meter)
- relative ink transfer: %

Ink consumption or ink transfer is the amount of ink transferred per print repeat from the ink container to the substrate surface in full tone equivalent.

Ink consumption or ink transfer is standardized for the printed area per print repeat so that the value indicates an ink film thickness in μm or an ink film weight per area.

Ink transfer in g/m² can be converted to ink transfer in μm when the ink density (specific weight) is known.

4. Test method

Ink consumption is measured by putting the ink tub (reservoir) on a scale and positioning a sensor inside the machine which records sheets passing through the machine or print repeats from the plate cylinder.

The value on the scale is recorded every time a sheet is detected or the plate cylinder completes one revolution.

Every time a sheet is detected or the plate cylinder completes a revolution the time and sheet or repeat count is recorded.

The recording of a scale value is dependent on the scale being ready to send a value to the computer. Scales are often relatively slow. It can therefore happen that, for example, at high speed only two out of three detected sheets will have a scale reading.

Ink consumption is the slope of a linear regression curve through all collected data points. It is calculated by applying a linear regression function on all ink consumption data points for the individual tests. The slope of the linear regression curve is calculated using the following equation:

$$b = \frac{\sum (x - \bar{x}) * (y - \bar{y})}{\sum (x - \bar{x})^2}$$

- b = ink consumption in g/print repeat
- x = sheet or print repeat number
- \bar{x} = average sheet or print repeat number
- y = weight for given sheet or print repeat
- \bar{y} = average weight for given sheet or print repeat

The slope value calculated from the collected ink consumption data will have a negative sign.

The sheet detection data will also provide information about machine speed.

The ink consumption can be converted in the ink film thickness transferred using the following equation:

$$IFT(m) = \frac{InkTransfer(kg / repeat)}{InkDensity(kg / m^3) * Area(m^2 / repeat)}$$

Ink transfer (in μm) can also be expressed as a percentage of the ink film thickness available on the surface of the screen roll for the flexo print process using the following equation:

$$\%IFT = \frac{IFTonSubstrat}{IFTonScreenRoll} * 100\%$$

Remark:

The ink consumption results might need to be reduced with the idle ink consumption which can be measured using TS0318, Printing, idle ink consumption. Idle ink consumption will need converting from idle ink consumption over time to idle ink consumption per sheet using the machine speed.

5. Results reporting

The first step of ink transfer measurement is to show the data collected as in the following graph:

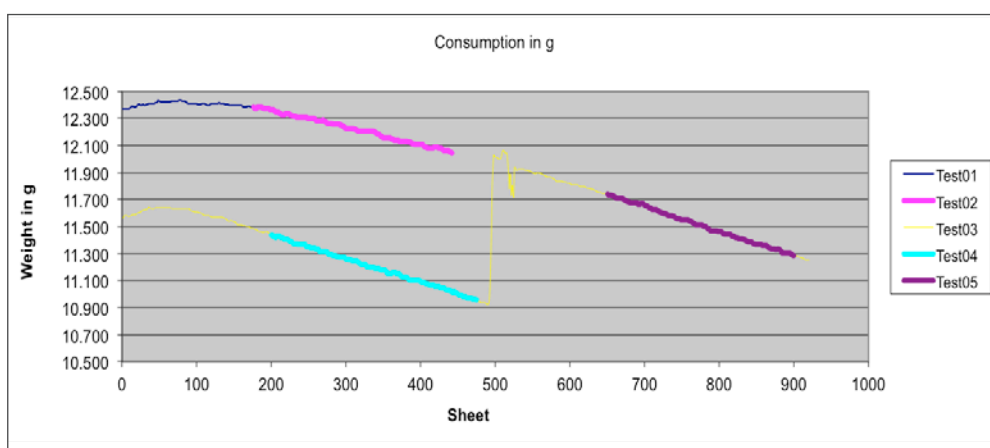

Note that the data collected show the start-up effect of the printing process. A data window is indicated (thick line) as the data used for calculating the ink transfer.

The following table is a representation of the three test results shown in the graph:

Test	Paper	Ink density Kg/m ²	Speed sht/h	Ink in g/sht	Ink in g/m ²	Wet ink film in μm
1 Halftone	White Top	1.076	12,000	1.287	7.391	6.867
2 Full tone	White Top	1.076	12,000	1.739	3.875	3.600
3 Full tone + Water	White Top	1.069	12,000	1.828	4.073	3.811

6. Target

Target levels are always agreed between customer and supplier.

The target speed for running the test is 90% of the maximum machine speed.

The target level for ink transfer needs to be in line with the type of substrate printed on.

The range for ink transfer value by substrate is as follows:

- uncoated liner: 5-8 μm
- coated liner: 2-3 μm

References:

- 1) TS0318: Printing, idle ink consumption

Rev#	Revision	Date
1.1	Added the correcting of ink consumption with idle ink consumption	3/5/16

Printing

Ink loss during colour change

1. Subject

The specifying and measuring of ink loss during colour change as used in the print and packaging industry during machine acceptance.

2. Application area

This specification can be used in the following area:

- printing machine: ink loss during colour change.

The specification can be applied to the following ink metering systems in combination with water based ink: two roll metering (TRM), doctor blade ink system and chamber doctor blade system.

This specification is used in combination with: TS0307 Water addition during colour change.

3. Definition

The units used for measuring ink loss during colour change are dm^3 (litre) and/or kg.

Ink loss during colour change is the difference between the amount of ink sent to the machine and returned after circulating the ink for a given time through the ink metering system.

It is important to realise that the ink returned from a printing machine might not be identical to the ink delivered due to residual water left in the machine after the wash cycle.

The following example explains how residual water affects ink loss during colour change:

Assuming that 10 kg ink is entered in the machine and 9.5 kg is returned the ink loss is 0.5 kg. However if there was 1 kg of water left in the system then the ink returned contains 10% water. That means that the 9.5 kg ink + water returned contains only 8.55 kg ink. Thus 1.45 kg was lost and not 0.5 kg. This is nearly three times more.

Ink loss during colour change can only be determined if the residual amount of water in the ink metering system after a wash cycle is known.

The measuring of the quantity of residual water in an ink metering system is defined in TS0307: Printing, water addition during colour change

4. Test method

The ink loss data collection procedure is as follows:

- Measure weight of empty container (ink tub)
- Fill container with ink
- Measure ink density
- Measure weight of container (ink tub) + ink
- Ink up the printing machine and circulate the ink for 5 minutes
- Retrieve ink from the metering system
- Measure weight of container + ink + water
- Measure ink + water density
- Calculate water addition and ink loss.

The equation for ink loss is:

$\text{Ink loss in kg} = \text{ink weight start} - \text{ink weight end} * (1 - \text{water addition}/\text{ink weight start})$

$\text{Ink loss in dm}^3 = \text{ink loss in kg} / \text{ink density start in kg/dm}^3$

5. Results reporting

Ink loss during colour change is reported as a single value in dm^3 .

The results are best reported in a spreadsheet that holds the equations for water addition during colour change and ink loss during colour change.

Note that:

- the density of water also needs measuring
- the ink bucket weight needs to be compensated in the equations
- the results for the test might be different when using an ink with a high or low density (specific weight). Ink with a high solid content might give a higher ink loss value.

6. Target

Target levels are always agreed between customer and supplier.

Target level for ink loss during colour change is $<0.5 \text{ dm}^3$. (2.4 m Doctor Chamber Blade)

References

TS0307: Printing, water addition during colour

Printing

Water addition during colour change

1. Subject

The specifying and measuring of water addition during colour change as used in the print and packaging industry during machine acceptance.

2. Application area

This specification can be used in the following area:

- printing machine: residual water in the ink system after colour change.

The specification can be applied to the following ink metering systems in combination with water based ink: two roll metering (TRM), doctor blade ink system and chamber doctor blade system.

This specification is used in combination with TS0306: Printing, ink loss during colour change.

3. Definition

The unit used for measuring water addition during colour change is dm^3 (litre).

Water addition during colour change is the residual water remaining in the ink metering system (e.g. pipes, pumps and ink chamber) after washing the ink system.

The residual water in the ink system has a negative influence on the measured ink loss during colour change for a metering system.

The following example explains how residual water affects the ink loss during colour change:

Assuming that 10 kg ink is entered in the machine and 9.5 kg is returned the ink loss is 0.5 kg. However if there was 1 kg of water left in the system then the ink returned contains 10% water. That means that the 9.5 kg ink + water returned contains only 8.55 kg ink. Thus 1.45 kg was lost and not 0.5 kg. This is nearly three times more.

The value for residual ink loss during colour change is needed when calculating the ink loss during colour change as described in TS0306: Printing, ink loss during colour change.

4. Test method

Measuring water addition during colour change is done by measuring the ink density (specific weight) at the start and end of the colour change procedure and measuring the ink weight sent to the machine and returned from the machine.

The following equation is used for measuring the water addition:

$$m_{\text{water}} = m_{\text{ink+water}} * \frac{\left(1 - \frac{\rho_{\text{ink+water}}}{\rho_{\text{ink}}}\right)}{\left(\frac{\rho_{\text{ink+water}}}{\rho_{\text{water}}} - \frac{\rho_{\text{ink+water}}}{\rho_{\text{ink}}}\right)}$$

m := weight in kg

V := volume in dm^3

ρ := density in kg/dm^3

The procedure for measuring the density of a liquid is based on using a scale (interval 0.01g) and a pipette that can hold a reasonably large volume of liquid. (50ml with a minimum accuracy of 0.3%).



The procedure for measuring ink density is as follows:

1. Switch on scale
2. Place plastic cup on scale
3. Zero scale
4. Place the 50 ml tip on the pipette
5. Set the dispense volume dial to 10. The display will indicate 10 ml
6. Fill the pipette and check that the liquid does not contain air. The display will flash 10 ml
7. Operate the pipette once, putting the liquid back into the original container. The display will stop flashing
8. Dispense 40 ml of liquid in plastic cup on scale by operating the pipette four times (by not using the last 10 ml ink left in the pipette will prevent air in the ink being dispensed)
9. Take reading from scale
10. Divide scale reading by 40 to get the density in kg/dm^3 .

For the test use a scale with an accuracy of $< 0.02 \text{ g}$ and a pipette with an accuracy of 0.3% . This will result in a density of water measurement error of $< 0.2\%$.

5. Results reporting

Water addition during colour change is reported as a single value in dm^3 .

The results are best reported in a spreadsheet that holds the equations for water addition during colour change and ink loss during colour change.

Note that the density of water also needs measuring.

6. Target

Target levels are always agreed between customer and supplier.

The target level for residual water after colour change is $< 0.1 \text{ dm}^3$

References

TS0306: Printing, Ink loss during colour change

Printing

Ink system cleanliness after wash-up

1. Subject

The specifying and measuring of **ink system cleanliness after wash-up** and the amount of wash-water or wash-time to do so as used in the print and packaging industry during machine acceptance.

2. Application area

This specification can be used in the following area:

- printing machine: ink system cleanliness after wash-up cycle in relation to wash-water consumption or wash-time.

The specification can be applied to the following ink metering systems in combination with water based ink: two roll metering (TRM), doctor blade ink system and chamber doctor blade system.

The colour difference used in this specification is measured according to the method described in the specification for measuring colour variation: TS303: Printing, colour variation.

3. Definition

The units used for measuring ink system cleanliness after wash-up are:

- wash-water consumption: dm^3 (litre)
- time measuring in minutes is optional if wash-water consumption can't be measured
- colour difference: ΔE using ASTM tables for light source: D65, angle 10° and standard observer 1964 [1].

Ink system cleanliness after wash-up is the cleanliness of the ink system in relation to the amount of wash-water or time used. The cleanliness of the ink system is measured as the contamination of ink resulting in a printed colour deviation between two identical ink samples. One printed when the ink system was clean or new and one after a wash cycle when black ink was circulated through the machine.

Ink system cleanliness can also be compared by looking at ink wet samples retrieved during the different tests.

4. Test method

The cleanliness is evaluated as the colour difference between print tests on white top kraft paper before and after washing the ink system using prepared ink varnish/medium samples and black ink.

For the test, standard un-heated tap water is used as wash-water without detergent. The hardness of the wash water should be standard to low.

Test procedure:

1. Ink system should be washed and cleaned as new.
2. Four varnish (medium) ink samples are prepared and three black ink samples. The ink sample size for the test is calculated using the following equation: $12 \text{ kg} + \text{width of the chamber in m} * 1 \text{ kg} = \text{ink amount in kg used for the test}$.
3. In the clean ink system one varnish (medium) sample is introduced and circulated for 5 minutes and a full tone area is printed after which an ink wet sample is taken.
4. The ink sample is removed and the system is washed (standard cycle).
5. The ink system is filled with black ink and is circulated for 5 minutes.
6. The system is washed using a minimum, standard or high wash-water amount (or wash-time). Wash-water is collected and the amount is measured and recorded or the wash-time for the cycle is measured.
7. Varnish (medium) is introduced and circulated for 5 minutes and a full tone area is printed after which an ink wet sample is taken.
8. The test is repeated for three wash cycles using low, standard and high wash-water quantity or wash-time.

9. The ΔE colour difference between the samples printed when the system was new and the three samples printed after using different wash-water quantities or wash-times is measured using a spectrophotometer according to the procedure described in TS0303: Colour variation

10. The ΔE in relation to wash-water quantity or wash-time used is presented in a graph.

If it is not possible to measure the wash-water quantity then it can be replaced by wash-time measured in minutes.

5. Results reporting

The ΔE is measured between the samples printed using varnish ink of the same batch on a clean (new) ink system and after introducing black ink in the system and washing the system using three different wash-water quantities (or wash times).

The measured ΔE between the samples printed when the system is clean (new) and the three samples printed using different wash-water quantities (or wash times) is presented in the following graph.

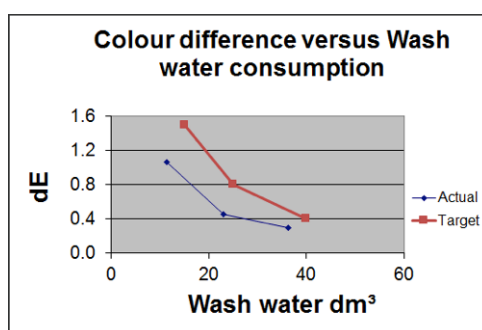

The graph is made from the following data table showing proposed values for the target and the actual ink system cleanliness:

Test#	Target Wash water in dm ³	Target ΔE	Actual Wash water in dm ³	Actual ΔE
1	15	1.5	11.3	1.1
2	25	0.8	23.0	0.5
3	40	0.4	36.3	0.3

Note that the actual line needs to be below the target line for the system to meet the pre-set target.

6. Target

Target levels are always agreed between customer and supplier.

Target ink system cleanliness values are:

Level	Wash water in dm ³	ΔE
Low	15	<1.5
Medium	25	<0.8
High	40	<0.4

References

1) TS303: Printing, colour variation

2) ASTM Designation: E 308 – 01, Standard Practice for Computing the Colors of Objects by Using the CIE System1

Rev#	Revision	Date
1.1	Added the option of wash-time measuring if wash-water quantity is not possible	25/04/16

Printing

Gap (barcode bar width variation)

1. Subject

The specifying and measuring of the gap between two rotating cylinders such as the screen roll and plate cylinder or the impression cylinder and plate cylinder as used in the print and packaging industry.

2. Application area

This specification can be used in the following areas:

- printing
- calendaring
- embossing

The specification can be applied to the following print methods: flexo, offset, screen, gravure.

3. Definition

The units used for measuring the gap between two rotating cylinders are:

- mm when measuring the actual gap
- percentage variation when using the results of bar width gain evaluation.

The following image shows the gap between two rotating elements such as between the screen roll and plate cylinder or the impression cylinder and plate cylinder.

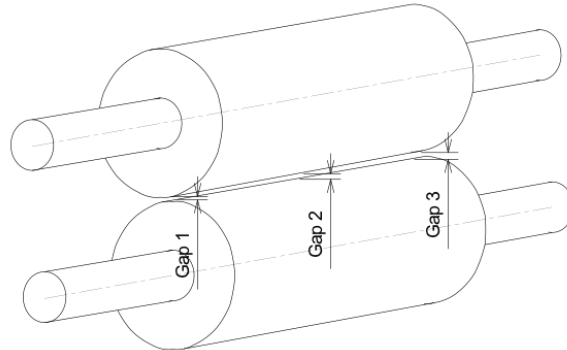

The gap is the minimum distance between two rotating elements.

The gap error is the difference between the set gap as shown on the machine panel and the measured gap.

Another way to check the uniformity across the machine width is by printing barcodes and evaluating the bar width gain.

The gap deviation across the machine width between two rotating cylinders is influenced by:

- total indicated run-out of the cylinders. See TS0301: Printing, TIR (screen roll, plate cylinder, impression cylinder)
- bearings of the cylinders
- alignment of the cylinders
- ink transfer or ink film thickness on the surface of the screen roll when using the barcode print method.

4. Test method

There are two methods for measuring the uniformity of the gap between two rotating cylinders:

- measuring the gap using feeler gauges
- measuring the uniformity in bar width gain across the print nip.

Measuring the gap using feeler gauges

The gap between the cylinders can be measured when the barcode bar width gain variation shows an above target value.

The gap measured between the cylinders needs to be safely accessible.

The gap setting shown on the machine control panel is recorded.

The minimum gap between the cylinders is measured in at least three positions using feeler gauges (as shown in the image under definition).

The measured values are recorded in a spreadsheet.

The gap is measured between:

- screen roll and plate cylinder
- impression cylinder and plate cylinder.

The deviation between the target gap and the actual gap is calculated.

Measuring the bar width gain uniformity across the print nip

The gap variation across both print nips can also be expressed as the bar width gain variation of printed barcodes.

The results of the test will not define which of the two gaps (between screen roll and plate cylinder or impression cylinder and plate cylinder) caused a deviation, if found.

In the following test form the black print plate has six positions: A to F, barcodes with bars in print direction and barcodes in cross print direction. Each barcode has an individual number to avoid barcodes being mixed up during data collection.

The barcodes are measured on at least 10 consecutively printed sheets.

The barcodes are measured using a calibrated barcode verifier such as the Axicon 6000. The value for bar width gain, which is derived from the verification scan, is recorded in a spreadsheet.

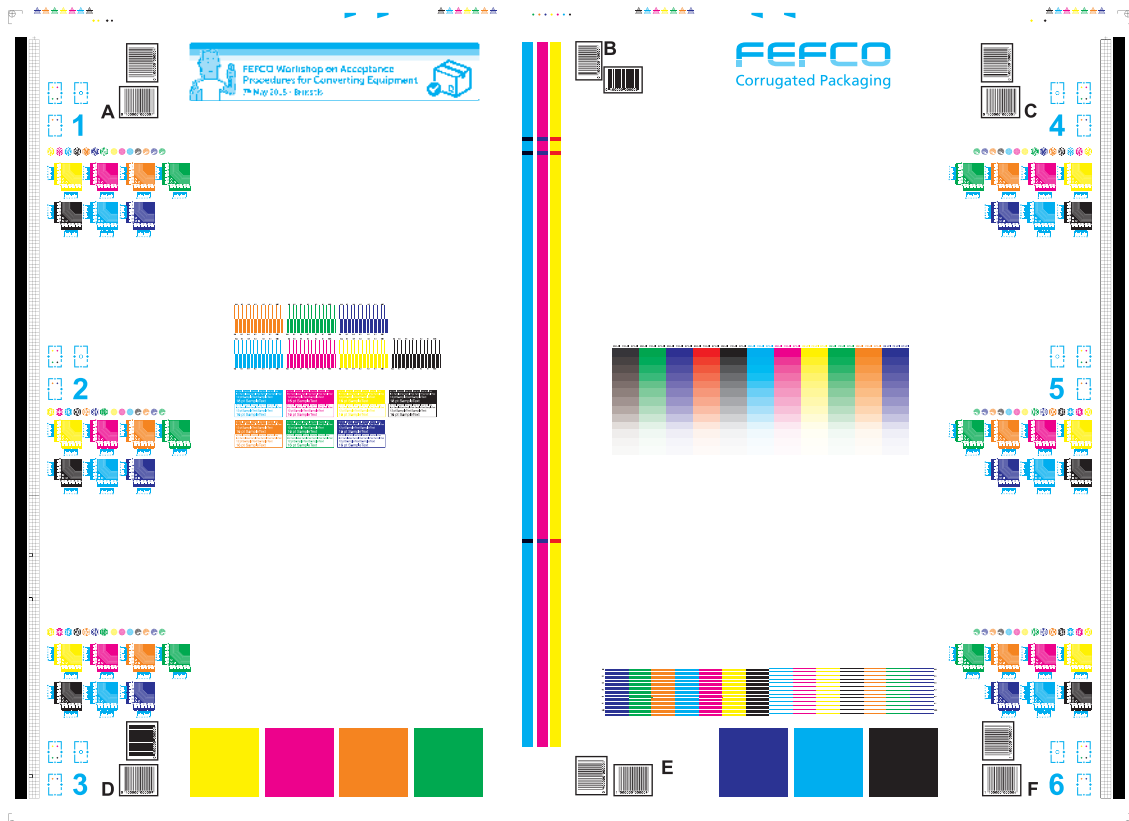

The black print plate is printed using black ink. The black print plate should be used on all print stations, printing at 90% of the maximum machine speed.

The bar width gain data is collected in a spreadsheet and separated in order to provide information about the bar width gain for the operator side, centre and drive side of the machine.

The following data is calculated from the collected bar width gain for the operator side, centre and drive side:

- average bar width gain
- the bar width gain standard deviation.

5. Results reporting

Measuring the gap using feeler gauges

The following example shows the results of a printing machine with two print stations.

The table shows the results for gap measuring on the operator side and drive side using feeler gauges where the target gap was 8 mm:

Station	screen roll/plate cylinder		plate cylinder/impression cylinder	
	OS	DS	OS	DS
1	8.05 mm	7.85 mm	8.30 mm	8.30 mm
2	7.45 mm	7.55 mm	7.50 mm	7.60 mm

Measuring the bar width gain uniformity across the print nip

The following example shows the results of a printing machine with two print stations.

The following graph shows the average bar width gain results for position AD, position BE and position CF.

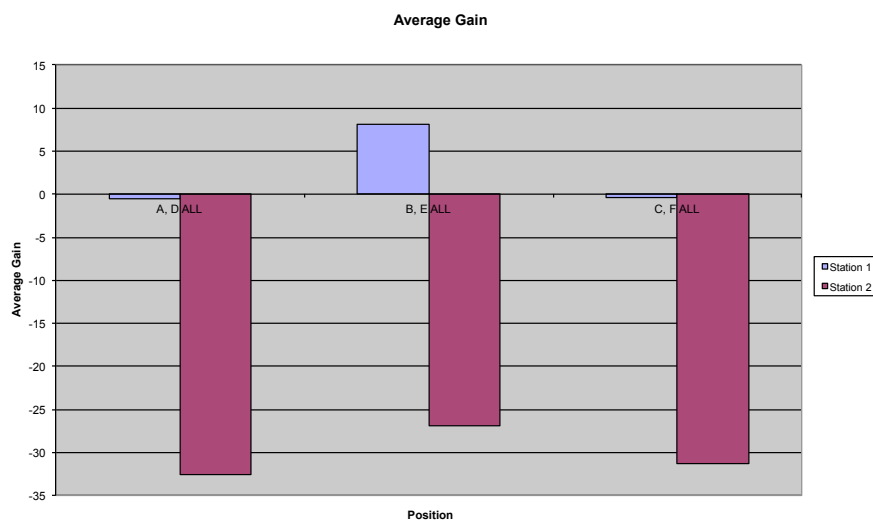

The following graph shows the bar width gain standard deviation results for position AD, position BE and position CF.

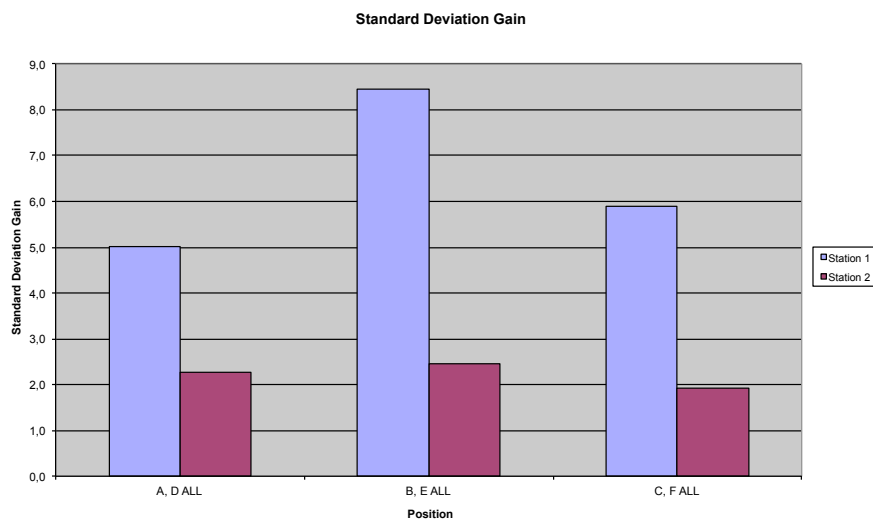

6. Target

Target levels are always agreed between customer and supplier.

The target speed for running the test is 90% of the maximum machine speed.

The proposed maximum gap deviation across the width for cylinders as used in corrugated board conversion equipment is < 0.015 mm.

The proposed maximum bar width gain variation across the width is $\sigma < 6\%$.

References

TS0301: Printing, TIR (screen roll, plate cylinder, impression cylinder)

Printing

Ghosting

1. Subject

The specifying and measuring of **ghosting** or duplication as used in the print and packaging industry during machine acceptance.

2. Application area

This specification can be used in the following area:

- flexo printing: ghosting/duplication between two or more print stations.

The specification can be applied to the following ink metering systems in combination with water based ink: two roll metering (TRM), doctor blade ink system and chamber doctor blade system.

3. Definition

The unit used for measuring ghosting is the number of repeats.

The ghosting referred to is defined as the ghosting caused by ink printed by stations 1 to X on the board. The printing plate of the next station (X+1) will pick up the excess ink from the board printed by stations 1 to X and transfer it to its screen roll. The excess ink is rewetted by the ink of station X+1 and transferred to the next board printed by station X+1.

This kind of ghosting only happens if there is an image or full-tone area on the printing plate (station X+1) in the position where the ink (stations 1 to X) is available on the board. This in the area for picking up the ink from the board but also for the excess ink that was transferred to screen roll X+1. This ink has to be picked up by the print plate of station X+1 and transferred to the next sheet printed.

Ghosting can already occur if ink is picked up from one of the stations 1 to X by station X+1.

4. Test method

A test element is needed to evaluate ghosting. The test element consists of a production direction full tone band printed by station X+1 and small cross print direction stripes in the full tone band printed by print station X.

The following is the dimensional design of the test element:

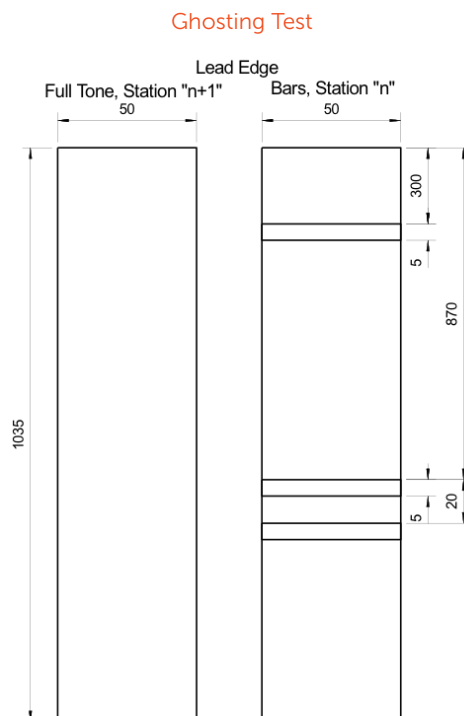

The following is the design of the test element as printed using four print stations. Printing order: black, cyan, magenta, yellow:



The following table shows the relation between the colours and which colour will ghost in the full-tone band:

Ghosting element	Black Cyan	Black Cyan Magenta	Black Cyan Magenta Yellow
Cross stripe colour	Black	Black Cyan	Black Cyan Magenta
Print station cross stripe colour	Station 1	Station 1, Station 2	Station 1, Station 2, Station 3
Full-tone colour	Cyan	Magenta	Yellow
Print station full-tone colour	Station 2	Station 3	Station 4

The number of stripe repetitions is counted by band. The double and single stripes allow an investigation into which of the two stripes is ghosting.

The level of ghosting depends on:

- ink drying properties
- ink viscosity
- ink transfer
- number of ink layers printed on top of each other
- screen roll configuration (line count and ink film thickness)
- use of drying systems
- air flow inside the printing station.

5. Results reporting

The following table shows the results of ten different test settings when using a four colour machine:

Test #	Total	Cyan Black	Magenta Cyan Black	Yellow Magenta Cyan Black
01	8	0	6	2
02	8	0	8	0
03	18	4	6	8
04	7	2	3	2
05	18	4	6	8
06	8	0	4	4
07	24	6	8	8
08	14	2	6	6
09	16	2	6	8
10	4	0	2	2

The Total column is the sum of the individual ghosting stripe counts by colour.

6. Target

Target levels are always agreed between customer and supplier.

The target speed for running the test is 90% of the maximum machine speed.

Target level for ghosting is a 0 stripes count

Rev#	Revision	Date
1.1	Changed single colour stripes printed in full-tone to multi-colour strips to be printed by station 1 to X	25/04/16

Printing

Stripes in print, encoder test

1. Subject

The specifying and measuring of **stripes in print** as used in the print and packaging industry during machine acceptance.

This specification evaluates the source for cross production direction stripes in print using the encoder test.

2. Application area

This specification can be used in the following area:

- flexo printing: cross production direction stripes.

3. Definition

The unit used for measuring stripes in print is m/s, ratio.

The encoder test is based on the principle that the surface speed of the screen roll and plate cylinder need to be equal at the smallest measurable increment of the print repeat ($V_{ScrRoll} = V_{PlateCyl}$). The screen roll slips against the printing plate if $V_{ScrRoll} \neq V_{PlateCyl}$.

The speed of the plate cylinder does not need to be constant over one print repeat. The drive for the plate cylinder can, for example, be set to stretch the print during part of the plate cylinder revolution. As a result, during another part of the revolution the plate cylinder shrinks so that timing is still correct. $V_{ScrRoll} = V_{PlateCyl}$ must be accounted for at any stage of the plate cylinder revolution when in contact with the screen roll.

The diameter of the screen roll is mostly smaller than the diameter of the plate cylinder. This results in a ratio of $C < 1$ for the angle speed increments (1 pulse) as shown in the following formula:

$$C = \frac{\frac{d\omega}{dt} \text{ PlateCyl}}{\frac{d\omega}{dt} \text{ ScrRoll}}$$

If the encoder used for the screen roll gives the same number of pulses per revolution as the encoder of the plate cylinder then:

$$C = \frac{D_{ScrRoll}}{D_{PlateCyl}}$$

Note that the ratio C also depends on the pressure setting between the plate cylinder and screen roll. A high pressure setting results in a compression of the plate on the plate cylinder resulting in a reduction of the diameter of the plate cylinder and an increase of ratio C .

4. Test method

Two encoders are used to measure if: $V_{ScrRoll} = V_{PlateCyl}$

One encoder is positioned directly on the shaft of the plate cylinder and the other encoder is positioned directly on the shaft of the screen roll.

The time in μsec is recorded for every individual pulse from the individual encoders. This is done using a data-logger.

The following is calculated from the pulse time for the individual rolls:

- revolutions per minute (RPM)
- surface speed V in m/s.

The ratio can be calculated for each plate cylinder pulse interval from the encoder data of the individual cylinders.

5. Results reporting

The following graph shows the RPM over time of every recorded pulse for five print repeats for each individual cylinder. In this example the plate cylinder shows deviations from the target due to, for example, stretching or shrinking of the print. (The simulated deviation is 0.0002 seconds over 50 pulses.)

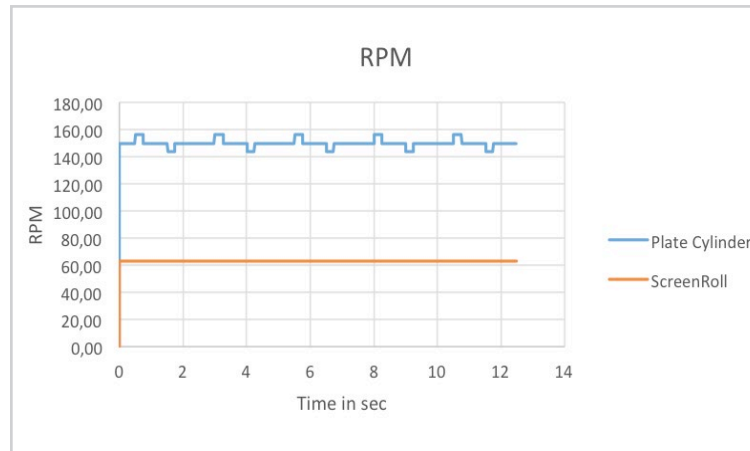

The following graph shows the surface speed over time for the two cylinders using the same encoder data as used for the RPM graph over time. The target is for both lines to be precisely on top of each other.

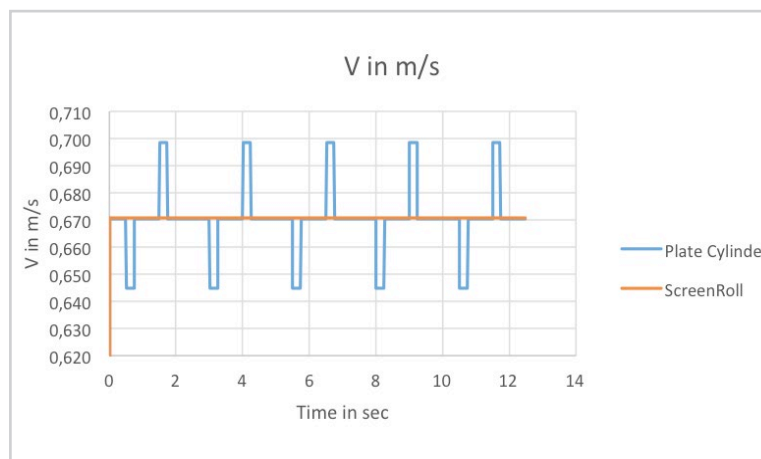

The example shows that the surface speeds are not at all identical. This is shown in the following graph for the ratio C over time.

6. Target

Target levels are always agreed between customer and supplier.

The target speed for running the test is 90% of the maximum machine speed.

$$V_{\text{ScrRoll}} = V_{\text{PlateCyl}} \rightarrow \text{Constant ratio between plate cylinder and screen roll}$$

Ratio C \rightarrow constant \pm 0.002

Rev#	Revision	Date
1.1	The RPM, V in m/s and RPM graphs were corrected. Target was reduced from \pm 0.000,2 to \pm 0.002	29/4/2015

Printing

Filling between dots

1. Subject

The specifying and measuring of filling between dots as used in the print and packaging industry.

2. Application area

This specification can be used in the following area:

- print: ink drying/scuffing, smearing, filling in.

The specification can be applied to the flexo print method.

3. Definition

The unit used for measuring filling between dots is percentage coverage.

Coverage is defined as the area covered by print, in this case dots. Filling between dots is the result of dots being printed larger than intended, in other words, higher coverage than the target.

The level of filling between dots depends on:

- coverage percentage in the design
- line count of the halftone area evaluated
- dot diameter
- ink
- ink viscosity
- drying system
- ink film thickness on the surface of the screen roll
- ink transfer
- substrate printed on
- pressure settings and printing nips.

4. Test method

A test form is used that has halftone areas as indicated with a coverage range of: 2%, 3%, 5%, 10%, 20%, 30%, 40%, 50%, 60%, 70%, 80%, 90% and 100% (full tone). These can be presented in three line counts and are printed as single colours: cyan, magenta, yellow, black and multicolour: cyan + yellow, cyan + magenta, yellow + magenta, cyan + yellow + magenta.

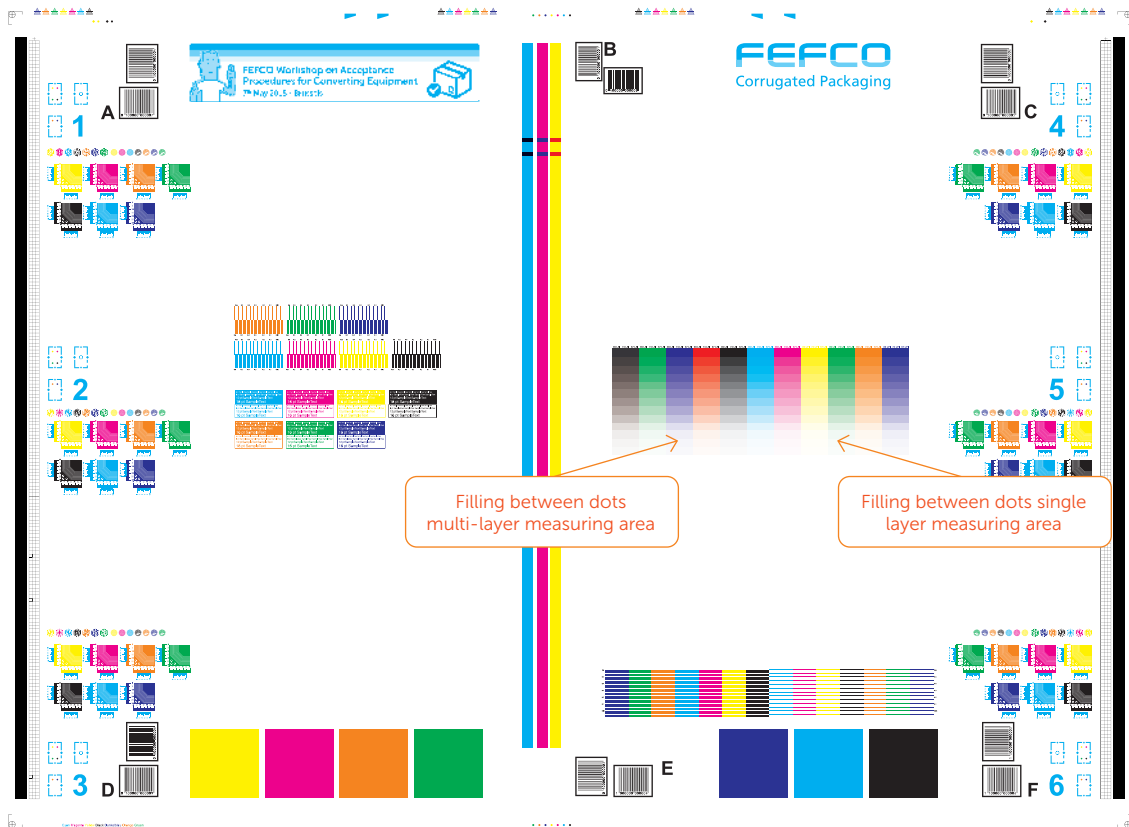

The test form is printed on at least 30 sheets. Sheet 25 is used for measuring the filling between dots. The filling between dots is measured using a spectrophotometer.

The single and multi-colour halftone areas are scanned using a flatbed scanner for documenting.

The spectral reflectance data of each of the individual halftone areas is measured.

The L, a, b values are calculated from the spectral reflectance data.

The calculation of the L, a, b values is done using the ASTM tables for light source: Δ65, angle 10° and standard observer 1964.

The a value represents an axis from green (-a) to red (+a). The b value represents an axis from blue (-b) to yellow (+b) and the L axis is where black is 0 and white is 100.

The following formula describes how the ΔE is calculated from the L, a, b values:

$$\Delta E = \sqrt{(L_{ref} - L_m)^2 + (a_{ref} - a_m)^2 + (b_{ref} - b_m)^2}$$

L_{ref} = L reference value

L_m = L measured value

a_{ref} = a reference value

a_m = a measured value

b_{ref} = b reference value

b_m = b measured value

The filling between dots can be calculated using the 100% full tone L, a, b values of the individual colour as the reference for that colour. The ΔE is then calculated between 100% and 90% coverage, using the individual measurements L, a, b, values, followed by the ΔE between 100% and 80% (and so on) up until 100% and the substrate 0% which is the maximum ΔE and represents the range.

The ΔE between 100% and 0% will be used as a relative value. The ΔE between the measured value on filling between dots x and 0% coverage divided by the ΔE between 100% and 0% is the value of the filling between dots.

The formula is as follows:

$$\%FillingBetweenDots = \frac{100 * (\Delta E0\% - \Delta Ex\%)}{\Delta E0\%}$$

% filling between dots = filling between dots value
 $\Delta E0\%$ = delta between 100% and 0%
 $\Delta Ex\%$ = delta between 100% and x%

The calculated filling between dots values can be shown in graphs relative to the filling between dots design value.

The total is calculated from the filling between dots data by halftone area as the sum of the difference between the target and the actual value for filling between dots values by area measured. This is the formula:

$$Filling\% = \sum_{0\%}^{100\%} (\%Actual - \%Target)$$

The target for the total filling between dots is 0%

5. Results reporting

Example Filling between dots graphs:

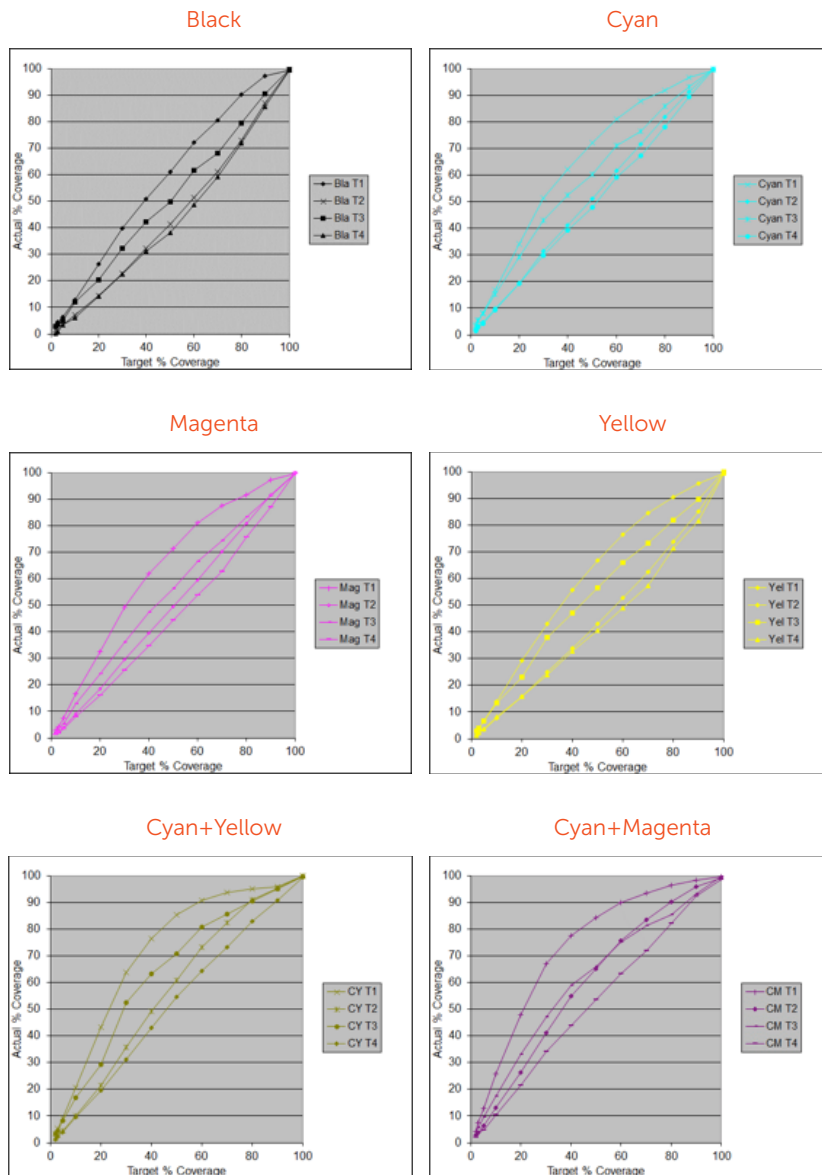

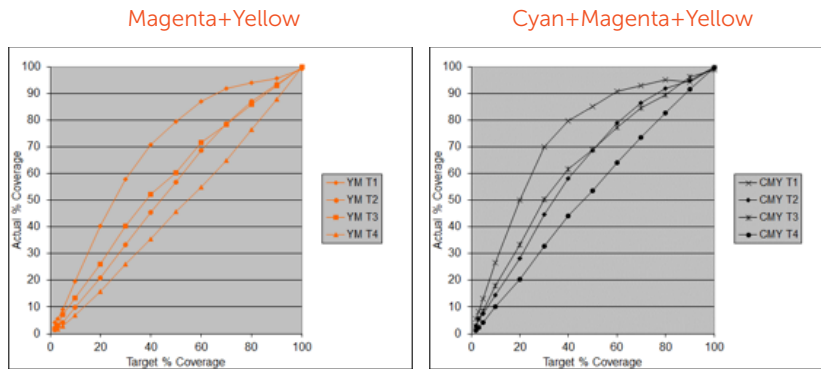

The following table shows the key total filling between dots results for the above graphs:

Colour	Test 1	Test 2	Test 3	Test 4
Black	84%	-63%	7%	-79%
Cyan	150%	8%	83%	-12%
Magenta	143%	-4%	43%	-47%
Yellow	108%	-55%	41%	-73%
Cyan + Yellow	223%	68%	139%	16%
Cyan + Magenta	244%	97%	116%	21%
Magenta + Yellow	194%	42%	73%	-40%
Cyan + Magenta + Yellow	250%	122%	135%	20%

6. Target

Target levels are always agreed between customer and supplier.

The target speed for running the test is 90% of the maximum machine speed.

Target values for filling between dots are:

- single colour: $-10\% < \text{filling between dots} < 100\%$
- multi-colour: $-0\% < \text{filling between dots} < 150\%$

References

ASTM Designation: E 308 – 01, Standard Practice for Computing the Colors of Objects by Using the CIE System1

Printing

Print scuff (drying)

1. Subject

The specifying and measuring of print scuff (drying) as used in the print and packaging industry.

2. Application area

This specification can be used in the following area:

- print: ink drying/scuffing

The specification can be applied to the flexo print method.

3. Definition

The unit used for measuring print scuff is ΔE .

The method for measuring ΔE is based on colour measuring using a spectrophotometer as described in TS 0303: Printing, colour variation.

Print scuff is the scuffing of dried ink from a printed area (single or multi layers) to an unprinted area. The following image shows an example of print scuff:



Print scuff is the ΔE colour difference between the area with print scuff and an unprinted area.

The level of print scuff depends on:

- ink
- ink viscosity
- drying system
- ink film thickness on the surface of the screen roll
- ink transfer
- substrate printed on.

4. Test method

A test form is used that has bands on operator and drive side where all colours are printed on top of each other, preferably four: yellow, magenta, cyan and black. These bands have a width of at least 10 mm.

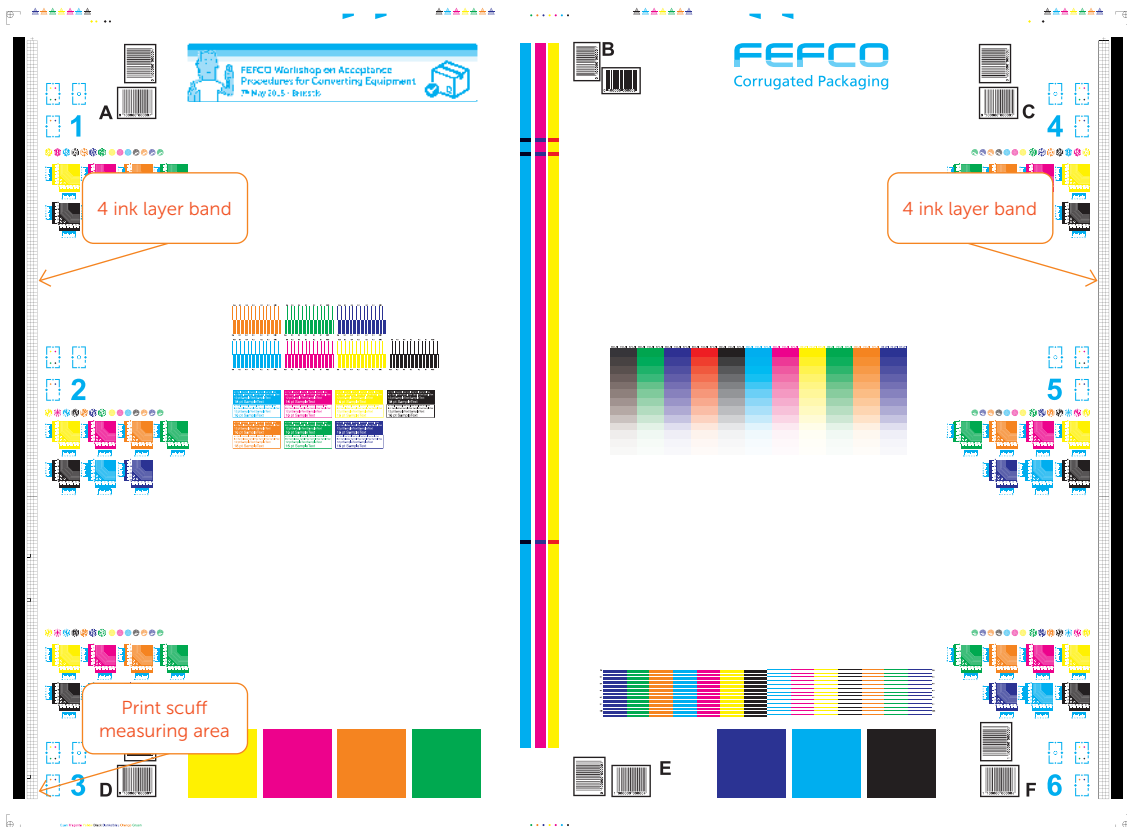

The test form is printed on at least 30 sheets. Sheet 25 is used for measuring print scuff. The print scuff is measured on the trail edge using a spectrophotometer.

Images of the operator side and drive side area are scanned where print scuff is measured.

The following are images of the operator side and drive side print scuff evaluation areas:



Print scuff is the ΔE colour difference between the area with print scuff and an unprinted area.

The colour of the print scuff area and unmarked area is measured using a calibrated spectrophotometer measuring colour in a wavelength range of at least 400 nm to 700 nm at intervals of 10 nm or lower.

The L, a, b values are calculated from the spectral reflectance data measured.

The calculation of the L, a, b values is done using the ASTM tables for light source: D65, angle 10° and standard observer 1964.

For evaluating print scuff the colour difference ΔE value is calculated from the unprinted area L, a, b values and scuff area L, a, b values calculated from the measured spectral reflectance curve using the following equation:

$$\Delta E = \sqrt{(L_{ps} - L_p)^2 + (a_{ps} - a_p)^2 + (b_{ps} - b_p)^2}$$

L_{ps} = L print scuff area

L_p = L unmarked area

a_{ps} = a print scuff area

a_p = a unmarked area

b_{ps} = b print scuff area

b_p = b unmarked area

5. Results reporting

The first part of the reporting is to show the scanned images.

The next step is to provide the ΔE print scuff value for operator side and drive side indicating the number of colours overprinted in the bands.

The results for the above images, which are four colour overprinted, are:

- operator side: $\Delta E=6.5$
- drive side: $\Delta E=0.5$

6. Target

Target levels are always agreed between customer and supplier.

The target speed for running the test is 90% of the maximum machine speed.

The target level for print scuff is: $\Delta E < 1.0$ (four colours overprinted)

References

- ASTM Designation: E 308 – 01, Standard Practice for Computing the Colors of Objects by Using the CIE System¹
- TS0303: Printing, colour variation

Printing

Gloss level

1. Subject

The specifying and measuring of **gloss level** as used in the print and packaging industry.

2. Application area

This specification can be used in the following area:

- print: gloss

The specification can be applied to the flexo print method.

3. Definition

The unit used for measuring gloss is the percentage (%) of light reflection off a surface when a red laser beam is projected at a set angle and the reflected light is measured on the opposite side at the same angle.

100% reflection means maximum gloss relative to a target gloss reference used for calibration. 0% gloss is a matt surface.

Gloss level depends on:

- the substrate surface of the original
- the lacquer applied on the surface
- the viscosity (water content) of the lacquer
- the lacquer film thickness as it is transferred from the screen roll to the substrate by the print plate.

Gloss can be measured on:

1. the surface of the unprinted substrate
2. a black printed surface
3. a surface printed with only lacquer
4. a surface first printed black and then overprinted with a lacquer.

Evaluation of the gloss increase for an applied lacquer film between a printed and unprinted area of a known substrate.

Measuring gloss level allows you to evaluate if the installed screen roll for printing lacquer transfers sufficient lacquer.

4. Test method

A large full tone area is used for gloss evaluation. First the gloss is measured on the unprinted substrate and then the gloss is measured on an area printed with lacquer. If possible this area should be printed black first with the lacquer applied on top.

Gloss level is measured in relation to the ink film thickness (IFT) (see TS0401: Screen roll, wet ink film thickness) and the line count value of the screen roll used for applying the lacquer (see TS0402: Screen roll, line count).

For measuring gloss, the Sheen 155 gloss meter can be used with a measuring angle of 75° <http://www.sheeninstruments.com/products/gloss/microgloss-155so>

All measurements need to be done using the same gloss measuring device and using the same measuring angle.

Measurements are done on at least 10 consecutive samples. The measuring order of the different areas on the sheet should always follow the same order to compensate for instrument drifting.

Data is collected in a spreadsheet and includes the IFT and line count value of the screen roll used.

5. Results reporting

The following graph shows the results using eight different screen roll IFT values. When printing the lacquer directly on the substrate and on a black ink layer the gloss level of the substrate is also measured:

The average of the individual gloss value data sets can be calculated and plotted in a graph in relation to the screen roll IFT and line count. In the following graph two data series are plotted by using low and medium line count screen rolls.

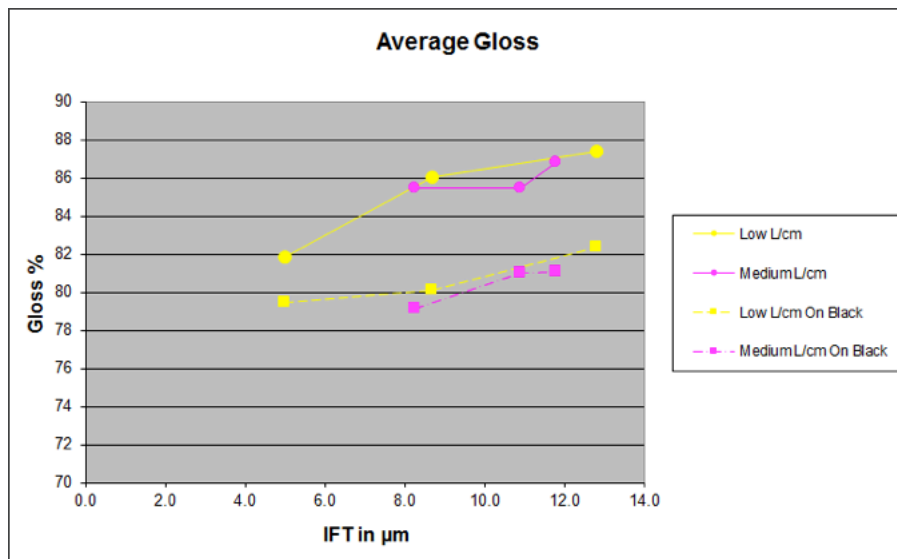
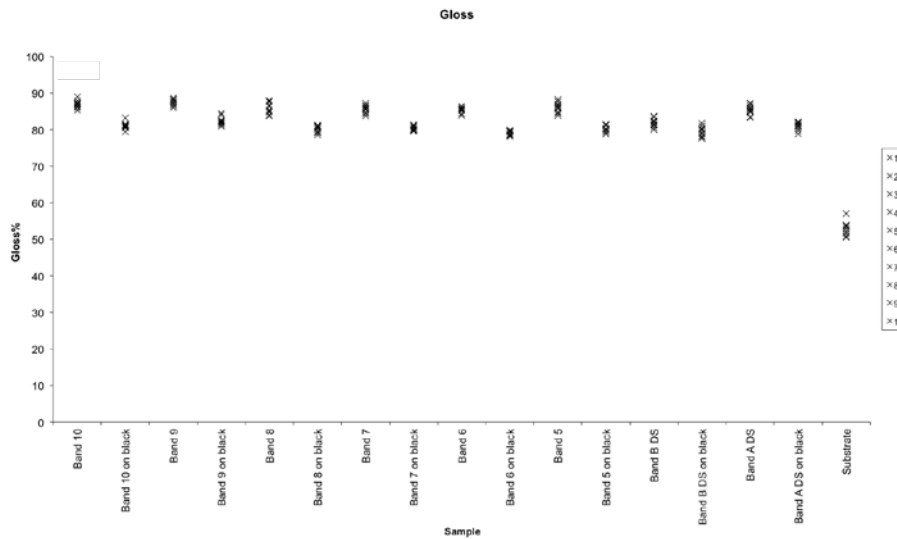

6. Target

Target levels are always agreed between customer and supplier.

The target speed for running the test is 90% of the maximum machine speed.

The target gloss levels by substrate are:

- uncoated: > 12%
- coated + lacquer: > 80%

References

- TS0401: Screen roll, wet ink film thickness
- TS0402: Screen roll, line count

Printing

Stripes in print, bouncing test

1. Subject

The specifying and measuring of **stripes in print** as used in the print and packaging industry during machine acceptance.

This specification evaluates the potential occurrence of cross production direction stripes in print using the bouncing test.

2. Application area

This specification can be used in the following area:

- flexo printing: cross production direction stripes.

3. Definition

The unit used for measuring stripes in print is ΔE (colour difference).

Bouncing is the up and down movement or deflection of the plate cylinder and/or screen roll. This results in a deviation in the gap between the screen roll and/or plate cylinder and the impression cylinder during one print repeat.

The bouncing test may manifest as a cross print direction stripe when the printed image is larger than half the circumference of the plate cylinder.

Bouncing of the machine can result in an unprinted area looking like a cross production direction band as shown in the following sketch.

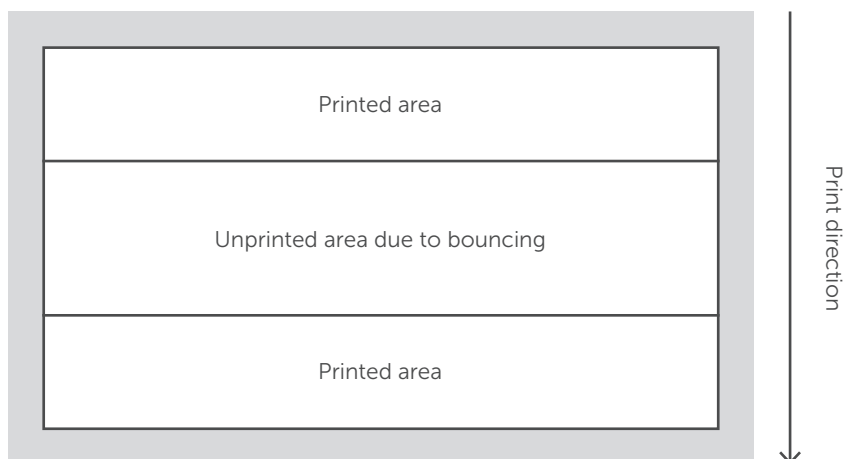

The band in the centre will have a lighter colour or the print will disappear completely.

The deflection of the cylinder is due to pressure differences in the gap during one print revolution. The following diagrams show two positions of the board in the machine and the corresponding position of the plate cylinder with the printing plate. The top cylinder is the impression cylinder, the bottom cylinder is the screen roll.

Sheet printing → higher pressure between screen roll and print plate

No sheet printing → lower pressure between screen roll and print plate

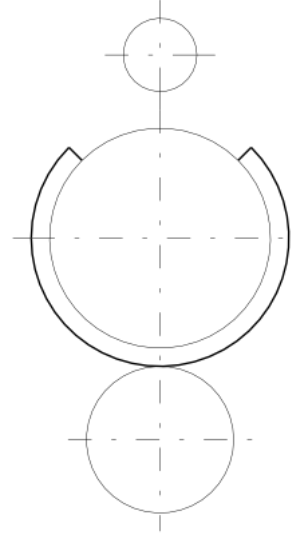
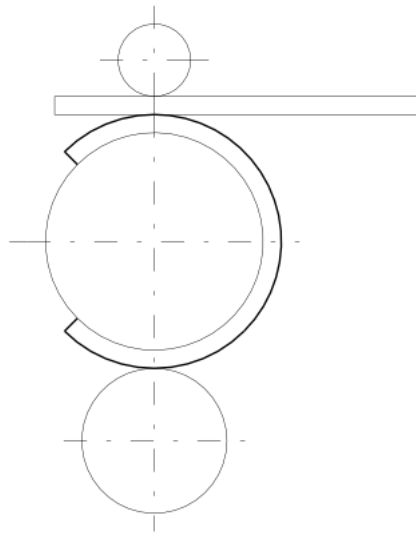

In the case where the board is between the plate cylinder and impression cylinder (the machine is printing) an additional force is applied by the impression cylinder pushing the plate cylinder against the screen roll. The force between screen roll and plate cylinder is less if there is no board between the impression cylinder and plate cylinder.

If one of the cylinders deflects then there will be bouncing.

The cross print direction stripe as a result of bouncing is measured as colour difference between the centre of the print and the lead edge and trail edge. The print can be a full tone or halftone print.

Colour difference due to bouncing is the ΔE colour difference between the centre and the lead edge/trail edge.

The colour of the centre area and lead edge/trail edge area is measured using a calibrated spectrophotometer which measures colour in a wavelength range of at least 400 nm to 700 nm and at intervals of 10 nm or lower.

The L, a, b values are calculated from the spectral reflectance data measured.

The calculation of the L, a, b values is done using the ASTM tables for light source: D65, angle 10° and standard observer 1964.

For evaluating bouncing, the colour difference ΔE value is calculated from the centre area L, a, b values and lead edge/trail edge area L, a, b values which are calculated from the measured spectral reflectance curve using the following equation:

$$\Delta E = \sqrt{(L_{ce} - L_{LT})^2 + (a_{ce} - a_{LT})^2 + (b_{ce} - b_{LT})^2}$$

L_{ce} = L centre area

L_{LT} = L lead edge/trail edge area

a_{ce} = a centre area

a_{LT} = a lead edge/trail edge area

b_{ce} = b centre area

b_{LT} = b lead edge/trail edge area

Sources for bouncing are:

- the potential of cylinders to deflect
- high pressure setting for print nips.

4. Test method

For the bouncing test a single colour full tone or halftone (40% coverage) print plate is used across the full machine width. The height of the print plate should be at least two-thirds of the circumference of the plate cylinder. The sheet used for printing should be of a corresponding size.

The machine is set to standard print conditions and pressure settings. Machine speed for the test is at least 60% of the maximum speed. The board grade should be an E flute board.

Coated liner is used for a screen roll with ink film thickness of $\approx 5\mu\text{m}$ and uncoated liner is used for a screen roll with ink film thickness of $\approx 10\mu\text{m}$.

At least 50 sheets should be produced per test run.

The test is repeated for each individual print station using the same print plate.

From each test 10 sheets (sheets 21-30) are taken and the colour data is collected from the centre of the lead edge and trail edge and recorded in a spreadsheet or data base.

The ΔE colour difference is calculated by sheet between the centre area and the lead edge/trail edge area.

5. Results reporting

The average ΔE colour difference for 10 sheets is presented by print station.

6. Target

Target levels are always agreed between customer and supplier.

The target speed for running the test is 90% of the maximum machine speed.

The target value for indicating that no bouncing stripes are present is: $\Delta E \text{ centre/LE-TE} < 1.0$

References

ASTM Designation: E 308 – 01, Standard Practice for Computing the Colors of Objects by Using the CIE System¹

Printing

Colour to colour register change during start-up

1. Subject

The specifying and measuring of colour to colour register change during start-up (mini-stops or feed interruptions) as used in the print and packaging industry.

2. Application area

This specification can be used in the following area:

- print: colour to colour register

The specification can be applied to any print method: flexo, offset, screen, gravure, digital, etc.

3. Definition

The units used for measuring are:

- colour to colour register change during start-up: #sheets (D Register > 0.5 mm)
- colour to colour register: mm (millimetre).

A colour to colour registration error is the distance between the printed positions of two separately printed elements that had the same position in the original.

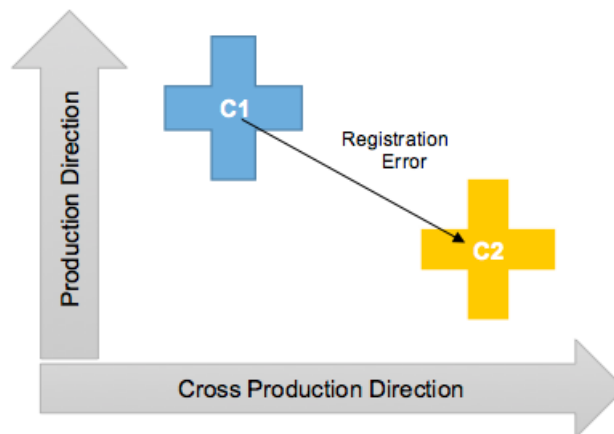

Above is an illustration of the registration error. Print register is two dimensional. A value needs to be measured for production direction (PD) and cross production direction (CPD).

The registration error is the linear distance. The following equation is used to calculate the registration error distance from the measured PD and CPD data:

$$R_{\text{error}} = \sqrt{PD_{\text{error}}^2 + CPD_{\text{error}}^2}$$

R_{error} = Distance between two positions

PD_{error} = Production direction distance between two positions

CPD_{error} = Cross production direction distance between two positions

Colour to colour register change during start-up is the number of sheets with higher target colour to colour register error relative to the average colour to colour register printed when the print process has stabilised.

The average colour to colour register printed, when the print process has stabilised, used for calculating the colour to colour register change during start-up is defined as the average colour to colour register of a series colour to colour register measurements on consecutive print repeats, such as sheets 21 to 30 after starting production. In other words the average PD value of sheets 21 to 30 PD value measurements of the measured colour to colour register and the average CPD value of sheets 21 to 30 CPD value measurements of the measured colour to colour register.

Colour to colour register change during start-up can be expressed as the number of sheets during start-up that have a colour to colour register difference larger than a target colour to colour register difference e.g.: Δ Register > 0.5 mm (This is the radius of a circle).

4. Test method

A specially designed test form is used which holds elements in designated positions that enables the measurement of the register error visually or using image analysis. The following is a design example for both.

Example element for visual measuring

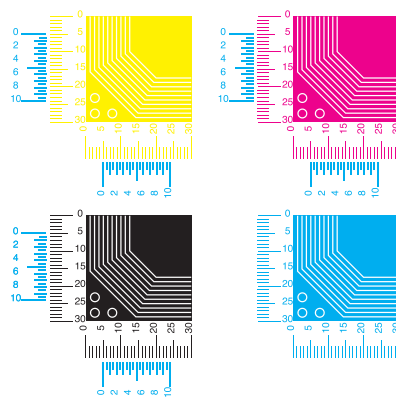

Example element for using image analysis



For evaluating colour to colour register change during start-up Δ Register values for sheets 1 to 30 are calculated from the average of all individual PD (print direction), CPD (cross print direction) values for sheets 21 to 30 and the individual PD, CPD values using the following equation:

$$\Delta \text{ Register} = \sqrt{(PD_{\text{avg}} - PD_m)^2 + (CPD_{\text{avg}} - CPD_m)^2}$$

PD_{avg} = PD average value sheet 21 to 30

PD_m = PD measured value

CPD_{avg} = CPD average value sheet 21 to 30

CPD_m = CPD measured value

The PD and CPD colour to colour register values are measured visually or using image analysis as shown before.

The colour to colour register is measured on the first 30 consecutive print repeats in the same position on every print repeat.

It is important that all print repeat sheets are collected for this test after hitting the start button. The print repeat sheets should be numbered.

5. Results reporting

The measured colour to colour register data for colour to colour register change during start-up can be presented in a graph as shown below:

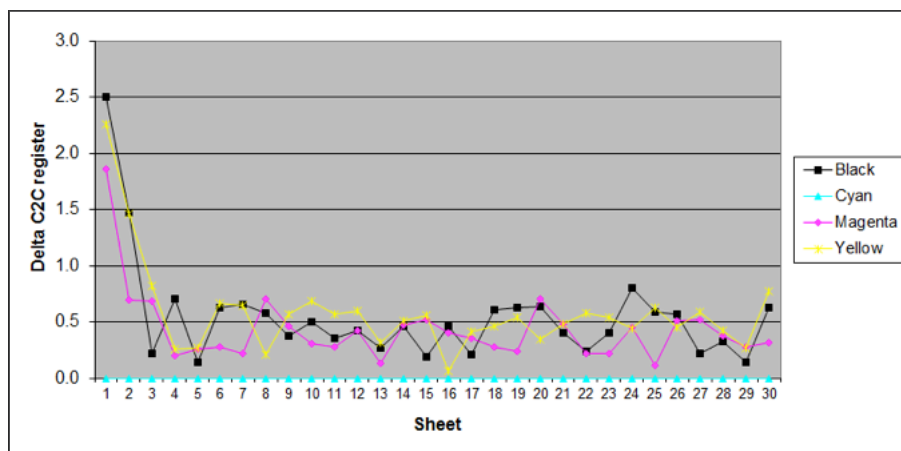

The colour to colour register change during start-up is quantified as the number of sheets that are above a given colour to colour register difference e.g.: Δ Register > 1.0

The following table shows the results in number of sheets by colour for the data of the above graph and target for fail: Δ Register > 1.0:

Test #	Speed	All colours	Black St 1	Cyan (ref.) St 2	Magenta St 3	Yellow St 4
01	12,000	3	2	-	1	2

There is no value for cyan as the register is measured relative to cyan.

6. Target

Target levels are always agreed between customer and supplier.

The target speed for running the test is 90% of the maximum machine speed.

Colour to colour register change during start-up depends on:

- the substrate (board grade)
- production speed
- sheet (board) transport system.

The proposed colour to colour register change during start-up target independent of substrate and production speed is 0 sheets.

- Low level: 0 sheets \rightarrow Δ Register > 1.5 mm
- Medium level: 0 sheets \rightarrow Δ Register > 1.0 mm
- High level: 0 sheets \rightarrow Δ Register > 0.5 mm

Printing

Start-up ink quantity

1. Subject

The specifying and measuring of the ink quantity needed to fill the ink system of a print station in the print and packaging industry during machine acceptance.

2. Application area

This specification can be used in the following area:

- print: start-up ink quantity.

The specification can be applied to the flexo, gravure and digital print methods.

3. Definition

The units used for measuring start-up ink quantity:

- start-up ink quantity: kg

Start-up ink quantity is the weight of ink needed to fill the complete ink system.

The start-up quantity is measured using ink varnish without colourant to minimize the impact of the ink density (composition) on the result.

Start-up ink quantity in kg can be converted to volume in dm^3 when the ink density (specific weight) is known.

4. Test method

Start-up ink quantity is measured by putting the ink tub (reservoir) on a scale.

The value on the scale is read every second and recorded as it changes.

The ink circulation system is started resulting in the ink leaving the ink bucket and entering the ink system: pipes, pumps, chamber, etc.

Start-up ink quantity is the difference in the reading of the scale between the weights recorded just before the ink circulation system is started until the ink bucket weight is constant within 20g for 10 seconds after the ink circulation system has been filled with ink.

The start-up ink quantity is influenced by:

- width of the machine
- piping system
- ink pumps
- metering system (two roll metering or doctor chamber blade system).

5. Results reporting

The first step of the start-up ink quantity measurement is to show the data collected as in the following graph (the graph also shows ink transfer data after 150 sec):

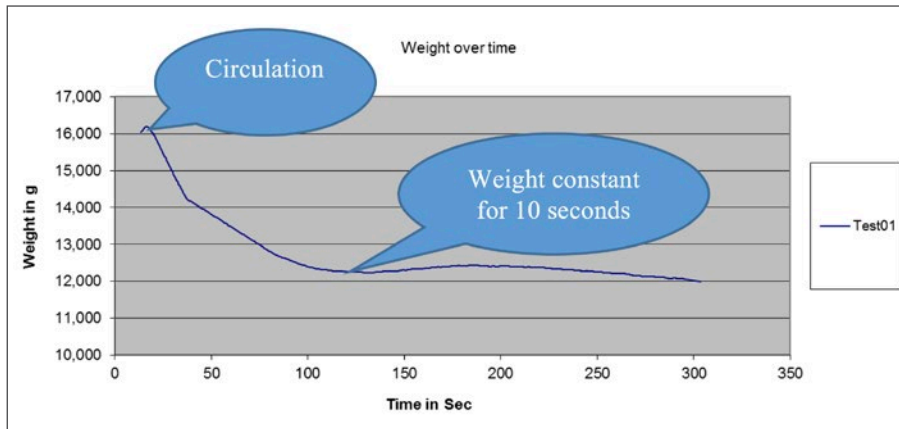

For this test:

- start value is 16.040 kg
- the first time the scale does not change more than 20 g for 10 seconds is after 128 sec: 12.250 kg

The start-up ink quantity needed in this case is 3.790 kg

6. Target

Target levels are always agreed between customer and supplier.

The start-up ink quantity has to be defined in function of the width of the machine. It is thus a linear equation:

$$Y = a \cdot X + b$$

- Y = start-up ink quantity
- X = width of the machine
- a = factor in kg/m for ink used to fill the ink system in function of the width
- b = fixed start-up ink quantity i.e. quantity used for filling the ink pumps.

The following "a" and "b" factors are realistic for determining a start-up ink quantity target: a = 0.75 kg/m and b = 3.0 kg. The start-up ink quantity for a 2 metre wide machine would be < 4.5 kg

Printing

Idle ink consumption

1. Subject

The specifying and measuring of the ink quantity used when a print station is running idle as used in the print and packaging industry during machine acceptance.

2. Application area

This specification can be used in the following area:

- print: ink consumption when running idle.

The specification can be applied to the flexo, gravure and digital print methods.

3. Definition

The units used for measuring idle ink consumption:

- idle ink consumption: g/sec

Idle ink consumption is the weight of ink used over time when ink is circulating in the ink system and the machine is running idle. This can be ink consumption due to, for example, leakage or evaporation.

The idle ink consumption can be measured when the print station is running idle and:

- the machine is producing products (using other print stations)
- the machine is not producing products

The idle ink consumption is measured using ink varnish without colourant to minimize the impact of the ink density (composition) on the result.

Idle ink consumption in g/sec can be converted to dm³/sec when the ink density (specific weight) is known.

4. Test method

Idle ink consumption is measured by putting the ink tub (reservoir) on a scale.

The ink system is started, filled with ink and ink is in circulation. The idle ink consumption data is collected from the moment the ink system is filled. This is when the ink bucket weight is constant within 20 g for 10 seconds.

The value on the scale is read every second. Weight and time are recorded if the weight changes.

Idle ink consumption is the slope of a linear regression curve through all collected data points. It is calculated by applying a linear regression function on all idle ink consumption data points for the individual tests. The slope of the linear regression curve is calculated using the following equation:

$$b = \frac{\sum(x - \bar{x}) * (y - \bar{y})}{\sum(x - \bar{x})^2}$$

b = idle ink consumption in g/sec

x = time of the measurement

\bar{x} = average time (time end-time start)/2

y = weight for given time

\bar{y} = average weight for given time

The slope value calculated from the collected idle ink consumption data will have a negative sign.

The idle ink consumption is influenced by:

- width of the machine
- piping system
- ink pumps
- metering system (two roll metering or doctor chamber blade system)
- air flow inside the machine.

5. Results reporting

The first step of idle ink transfer measurement is to show the data collected as in the following graph:

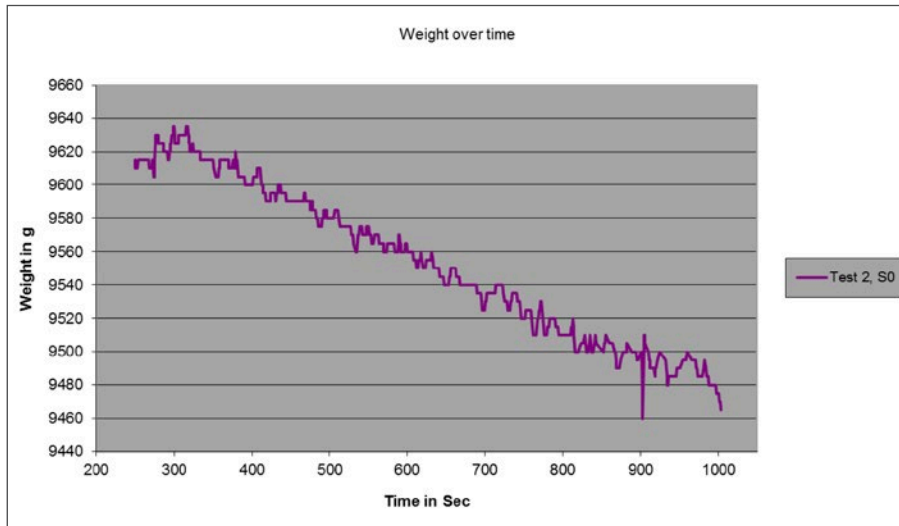

Note that the ink system filling data has been removed from the test.

The slope calculated from the data points is 0.210 g/sec

The test shows that 756 g/hour ink is lost.

6. Target

Target levels are always agreed between customer and supplier.

Idle ink consumption: < 1,000 g/hour → < 0.277 g/sec

References:

- 1) TS0305: Printing, Ink consumption

Printing

Ink stability over time on the press Viscosity & pH

1. Subject

The measuring of ink stability over time in terms of viscosity and pH on a print station as used in the print and packaging industry.

2. Application area

This specification can be used in the following area:

- print: ink stability water based ink.

The specification can be applied to the flexo and gravure print methods.

3. Definition

The units used for measuring water based ink stability:

- viscosity: sec using a Din4 (Ford4) flow cup
- pH (pH uses a negative logarithmic scale!)

The ink stability of water-based ink is the viscosity and pH stability over time when running the machine under different conditions:

- circulation of ink when machine is running idle
- circulation of ink and machine (vacuum) transport system switched on (Air flow).

Ink viscosity and pH should remain constant over an agreed period of time.

Ink circulating in an ink system tends over time to:

- increase in viscosity
- lower in pH.

4. Test method

Before starting the test, the following are measured and recorded:

- environmental temperature
- relative humidity.

A din 4 (ford4) viscosity cup is used for measuring the ink viscosity. The viscosity of the ink is measured every 5 minutes over a period of at least 30 minutes. Measuring time and viscosity are recorded in a spreadsheet. Recommended start viscosity for the test is 18-23 seconds din 4.

Using the same time intervals and test duration as used for measuring viscosity, the pH is measured using a temperature corrected and calibrated pH meter. Start pH is around 8.5-9.0.

Tests are done using batches of the same ink. It is recommended to use ink varnish without colourant to minimize the impact of the ink composition on the result.

The ink stability over time is measured when the screen roll is rotating, the machine is closed and:

- vacuum transport fan is OFF
- vacuum transport fan is ON.

The ink stability over time is influenced by:

- width of the machine
- piping system
- ink pumps
- metering system (two roll metering or doctor chamber blade system)
- air flow inside the machine
- environmental temperature
- relative humidity in the environment.

5. Results reporting

Conditions during the test:

- environmental temperature was 19°C
- relative humidity was 30%.

The following graph shows the ink stability over time results when:

- vacuum transport fan is OFF
- vacuum transport fan is ON

Right-hand graph: viscosity change over time.

Comment: Viscosity does not change significantly, regardless of whether the vacuum transport fan is switched on or off.

The delta viscosity between start and end is calculated.

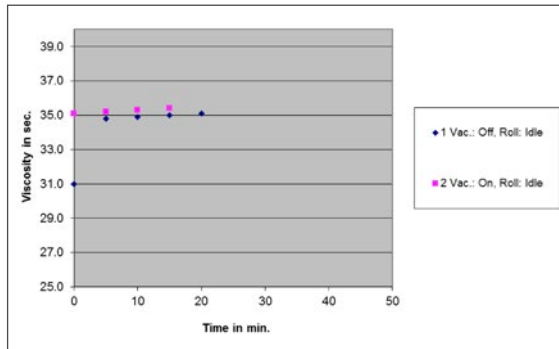

Right-hand graph: pH change over time.

Comment: There is no clear trend visible in the pH values

The delta pH between start and end is calculated.

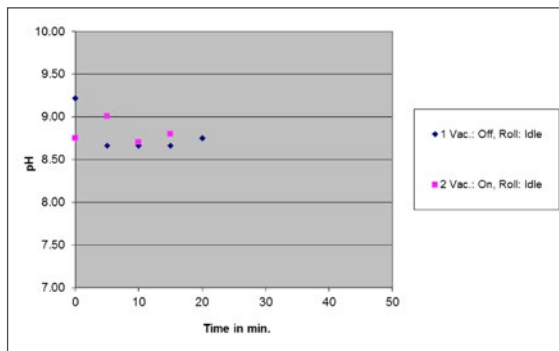

The graph shows the correlation between viscosity and pH for the measurements.

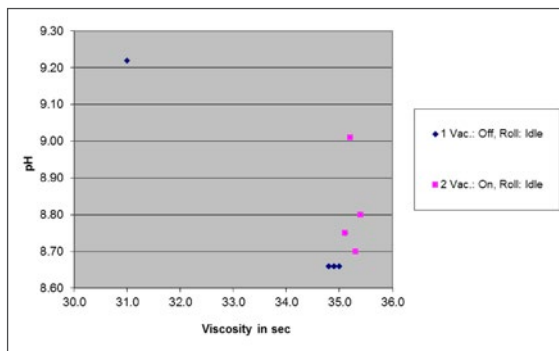

6. Target

Target levels are always agreed between customer and supplier.

Over a time period of 30 minutes the changes recorded were:

- ink viscosity: < 2 sec din 4
- ink pH < 0.2 points on the pH scale

Printing

Dot stretch variation during one print repeat

1. Subject

The measuring and evaluation of local print direction dot stretching in parts of one plate cylinder print repeat on a print station as used in the print and packaging industry.

2. Application area

This specification can be used in the following area:

- print: stretching of dots.

The specification can be applied to the flexo print method.

3. Definition

The unit used is % print direction dot stretch

The source for dot stretching may be linked to other test results such as the encoder test as described in FEFCO technical specification for converting equipment, technical specifications for equipment and process: FC0311: Printing, stripes in print, encoder test" [1].

The local print direction dot stretching in half-tone areas can result in cross print direction stripes in printing, which are commonly referred to as gear stripes.

Half-tone dots printed by a print station can stretch locally in the print direction. This can result in half-tone dots that are round at a distance of X mm, 3*X mm and 5*X mm from the lead edge and that the same dots are printed stretched at 2*X mm and 4*X mm from the lead edge. The following images are an example:

Cyan dots are round



Cyan dots stretched in print direction



Dots are stretched when: $(\text{print direction length}/\text{cross print direction width} - 1) * 100 > 15\%$

Dot stretching is measured in intervals relative to the print lead edge (or trail edge). The distance between the dot stretch measuring position and the lead edge is measured and recorded in a table together with the dot stretch %.

4. Test method

A test plate is used for each colour, with a half-tone area of 500 mm wide and covering the full print repeat of the plate cylinder. The recommended half-tone specification is 32 l/cm and a coverage of 5%. This half-tone specification results in a nominal dot diameter of 79µm. The printed dot size can be significantly larger due to dot gain.

Next to the half-tone band a ruler can be printed in the print direction with a resolution of 1 mm. This ruler can be used to record the distance where images are taken relative to the print lead edge.





The printing is conducted on coated substrate preferably using a hexagonal cell shape screen roll with a low ink film thickness, for example, 5 µm ink film thickness in combination with a 180 l/cm hexagonal cell screen on the surface of the screen roll.

The print test is conducted using different machine speeds, e.g. 50%, 70% and 90% of the maximum machine speed. This is to evaluate the impact of the production speed on the occurrence of dot stretching and the location in the print repeat of dot stretching if it occurs.

Images are taken using a digital microscope with a magnification of at least 200x. The distance is recorded relative to the print lead edge of where the image is taken.

5. Results reporting

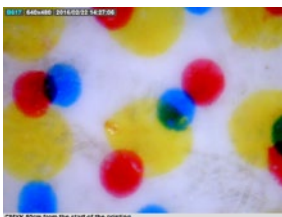
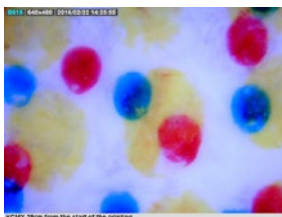
After the print test and the taking of images of the half-tone dots, a report can be created and presented with a table of images as shown:

Distance to lead edge mm	70% machine speed	90% machine speed
100		
400		
700		
etc		

The dot stretching is measured in the images taken and reported in a table by colour as follows:

mm	70% machine speed				90% machine speed			
	C	M	Y	K	C	M	Y	K
100	50	10	1		2	2	5	
400	5	2	1		10	5	45	
700	50	45	1		5	2	5	
Etc.								

6. Target

Target levels are always agreed between customer and supplier.

Local dot stretch in one print repeat: < 15%

References:

- 1) TS0311: Printing, Stripes in print, encoder test

Printing

Defects in print

1. Subject

The measuring and evaluation of print defects, i.e. no print, in a single colour, full-tone area in the print and packaging industry.

2. Application area

This specification can be used in the following area:

- print: full-tone print defects.

This specification can be applied to any print method: flexo, offset, screen, gravure, digital, etc.

3. Definition

Print defects are areas where there is no print where print was expected. Defects may be linked to dust on board and/or print tool defects for analogue print methods or a blocked nozzle for digital print methods.

Print defects are measured by detecting unprinted areas in a single colour, full-tone area, preferably black print on a white surface substrate.

The unit used for measuring print defects is a percentage (%) of a single colour, full-tone area in the original where there is print in the reproduction. If the measurement indicates 100% then there are no print defects (unprinted areas).

4. Test method

A white surface substrate is printed with single colour, black, full-tone areas of a size larger than an A4 sheet.

11 sheets are produced with an interval of 100 sheets. Three A4 size samples per sheet are taken in the same pre-determined area of the printed, single colour, full-tone design.

A scan is made of the A4 samples using a flatbed scanner and the scanned image is evaluated using image analysis software which will provide a value for the percentage coverage. The coverage represents the printed area.

The image analysis is based on deciding if a pixel is white or black. If a pixel is identified by the image analysis software as being black then it is part of the full-tone area, if it is identified as white it is an unprinted area and thus part of a defect.

A pixel in the image can have a value between 0 (black) and 255 (white). The threshold value, a value between 0 and 255, is the value at which the pixel changes from black to white. If the threshold is set at 0 then all pixels after the evaluation are viewed as white. If the threshold is set at 255 then all pixels are viewed after the evaluation as black. A common threshold value for evaluation is between 180 and 190.

The result of the print defect image analysis evaluation is a percentage, where 100% indicates no dust on the board and no defects.

The following is a sample full-tone area scan and the image after processing:

Raw Data



Evaluated data (threshold 186)



The full-tone coverage is 95.96%

Image analysis is able to generate a histogram for the defect size distribution of the above image where the size of the defect is expressed in number of pixels:

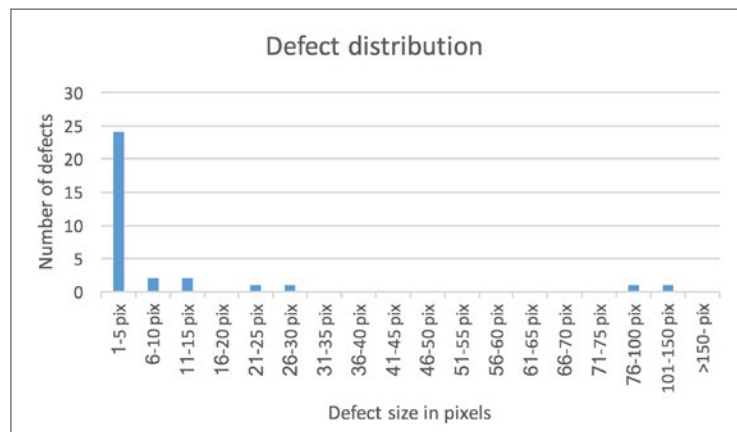

Print defects in print are influenced by:

- amount of dust in the environment
- amount of dust on the substrate
- ink absorption of the substrate
- ink film thickness printed on the substrate.

5. Results reporting

The results of scanning the 150 test samples are presented in a graph showing the full-tone coverage in function of the sample (sheet) number.

The following sample graph of artificial data shows the full-tone coverage for two different settings:

- print plate cleaning ON (1 PC ON)
- print plate cleaning OFF (2 PC OFF)

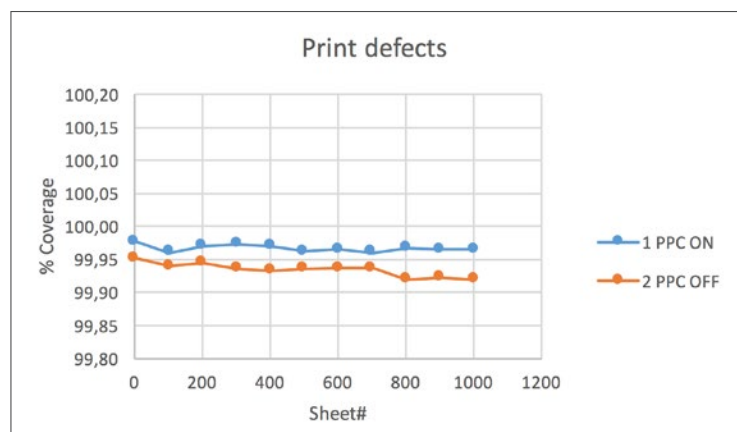

6. Target

Target levels are always agreed between customer and supplier.

Proposed target print defect values in function of the outer liner:

- Uncoated outer liner >99.50%
- Coated outer liner >99.95%

Printing

Dryer performance

1. Subject

The measuring of the dryer performance on a full-tone, multi-colour area as used in the print and packaging industry.

2. Application area

This specification can be used in the following area:

- print: drying of printed area.

This specification can be applied to any print method using water based ink: flexo, offset, screen, gravure, digital, etc.

3. Definition

Units used for measuring dryer performance:

- dry/wet ink film ratio: %
- energy: W/m² (watt per meter square substrate)

The function of the dryer is to drive out the moisture of the ink after printing. The dryer performance can be measured in function of energy efficiency.

The dryer performance can be expressed as the ratio between the wet ink film weight (g/m²) applied and the dry ink film weight (g/m²) on the substrate of the printed product. The dryer performance is measured when the dryer is in use and when it is not, in function of the energy consumed by the dryer.

Equation for calculating dry/wet ink film ratio:

$$DWratio = \frac{Substrate_{Start} - Substrate_{End} * 100\%}{\Sigma InkTransfer - \Sigma IdleCons.}$$

DWratio	= dry wet ink film ratio in %
Substrate _{Start}	= weight of the unprinted substrate in g
Substrate _{End}	= weight of the printed substrate in g
ΣInkTransfer	= sum of the wet ink weight used to print the sheets in g
ΣIdleCons.	= sum of the idle wet ink weight used in g

The wet ink film thickness is measured according TS0305 and compensated for idle ink consumption using TS0318.

The DWratio percentage can be compared to the ink solid content percentage. The following equation gives a value for the ink dryness relative to the ink solid content:

$$InkDryness = \frac{DWratio}{InkSolidContent}$$

InkDryness	= the ink dryness % relative to the solid content %
DWratio	= dry wet ink film ratio in %
InkSolidContent	= solids in ink %

100% ink dryness means that all liquids were removed from the ink.

Equation for dryer performance:

$$DryerPerf. = \frac{DW_{on}}{DW_{off}} * 100\%$$

DryerPerf.	= dryer performance for a given energy consumption in %
DW _{on}	= dry wet ink film ratio for a given energy consumption in %
DW _{off}	= dry wet ink film ratio dryer off in %

The dryer energy consumption can be measured to determine its efficiency.

Equation for calculating dryer efficiency:

$$\text{DryerEff.} = \frac{\text{DryerPerf.}}{\text{EnergyCons.}} * 100\%$$

DryerEff. = dryer efficiency for a given energy consumption in %

DryerPerf. = dryer performance for a given energy consumption in %

EnergyCons. = energy consumption in W/m²

4. Test method

The test method is split into two parts:

- measuring the dry/wet ink film ratio
- measuring the dryer energy consumption.

Dry/wet ink film ratio

Method for dry/wet ink film ratio data collection.

Preparation:

- Screen rolls are installed on four print stations with an ink film thickness (IFT) of 11 µm according TS0401 and a line count of 100 l/cm or similar according TS0402.
- A full-tone print plate is installed on four print stations with a printing area of >2m².
- The substrate printed on is uncoated liner. The make and type are recorded.
- The full width of the machine over which heat is applied by the dryer is recorded.
- Tests are done at 90% of the maximum machine speed.
- For each test use four buckets of a fresh ink varnish (medium ink without colourant), each weighing 10 kg.
- The varnish ink is diluted with water to a 50/50 ratio by adding 10 kg of water taking into account the water left in the ink system after washing as measured using TS0307.
- Take a 100 ml ink wet sample for measuring the ink solid content.
- The machine is set up for measuring ink consumption according TS0305. Note that the ink consumption as recorded for the first 75 sheets after starting might be influenced due to ink push-back from the ink system to the ink tub.
- Using a fresh ink series, the idle ink consumption is measured for each print station according TS0318.
- The machine is set up for kiss touch printing and checked that the full-tone area is printed correctly.
- The estimated ink consumption per test per colour is around 1.5-1.8 kg.

Method for dry/wet ink film ratio data collection, test procedure:

- Measure the weight of > 200 unprinted sheets and record the exact sheet count and weight using a scale with an accuracy of +/- 5 g.
- Load four fresh ink buckets on the four print stations.
- Print 250 sheets with the dryers switched off using four print stations and measuring the ink consumption of the four individual print stations
- Measure the weight of > 200 printed sheets and record the exact sheet count and weight using a scale with an accuracy of +/- 5 g.
- Load four fresh ink buckets on the four print stations.
- Print 250 sheets with the dryers switched on at 20% power level using four print stations and measuring the ink consumption of the four individual print stations.
- Measure the weight of > 200 printed and dried sheets and record the exact sheet count and weight using a scale with an accuracy of +/- 5 g.
- Repeat steps 5, 6 and 7 with the dryer power level at 50% and 100%.
- Calculate for each test the dry/wet ink film ratio taking into account the idle ink consumption of the individual print stations.

Dryer energy consumption

The energy consumption is an optional measurement and can be done independent of the dry/wet ink film ratio data collection.

The dryer energy consumption is measured when operating the dryer over the full cross production direction machine width at 20%, 50% and 100% of its capacity (maximum power consumption).

When the dryer control system is temperature controlled then 100% is the maximum allowed temperature.

Energy consumption by dryer type:

- Infrared dryer: a power consumption meter is installed in the main power line. Optionally the current (A) and voltage (V) are measured for the different operational modes.
- Gas heated dryer: a gas meter measuring the gas volume supplied to the dryer is used when operating the dryer in different modes. It is important to monitor time so a value of m³/sec can be calculated. The gas company is asked to provide the normalised gas energy content in J/m³. Multiplying gas consumption over time and the normalised gas energy value results in an energy consumption value in Watt (Joule/sec) when printing and drying.
- Steam heated dryer. For a steam heated dryer it is important to measure the temperature drop and pressure drop over the heat exchanger at the same time with the actual steam consumption in kg/sec. The energy consumption can be calculated using a steam table where the steam energy content is consulted for the steam entering and leaving the heat exchanger. The delta energy content times the kg/sec of steam consumed is a value for the energy consumption.

The dryer performance measurements are influenced by:

- width of the machine
- speed of the machine
- ink used
- screen roll used
- substrate printed on (this might also be dried using the dryer system. Run a test without printing to check this)
- environmental temperature
- relative humidity in the environment.

5. Results reporting

During the test

- the environmental temperature was 19°C
- the relative humidity was 30%.

The results of the dryer tests are shown in the following table:

TestID	Dryer cap.	Speed m ² /sec	Energy W/m ²	Sub.	DWratio	Ink dryness	Dryer perf	Dryer eff.
1	0%						N/A	
2	20%							
3	50%							
4	100%							

6. Target

Target levels are always agreed between customer and supplier.

Target levels for dry/wet ink film ratio, ink dryness and dryer energy efficiency have to be determined!

References:

- TS0305: Ink transfer
- TS0307: Printing, water addition during colour
- TS0318: Idle ink consumption
- TS0401: Wet ink film thickness
- TS0402: Line count

Screen Roll

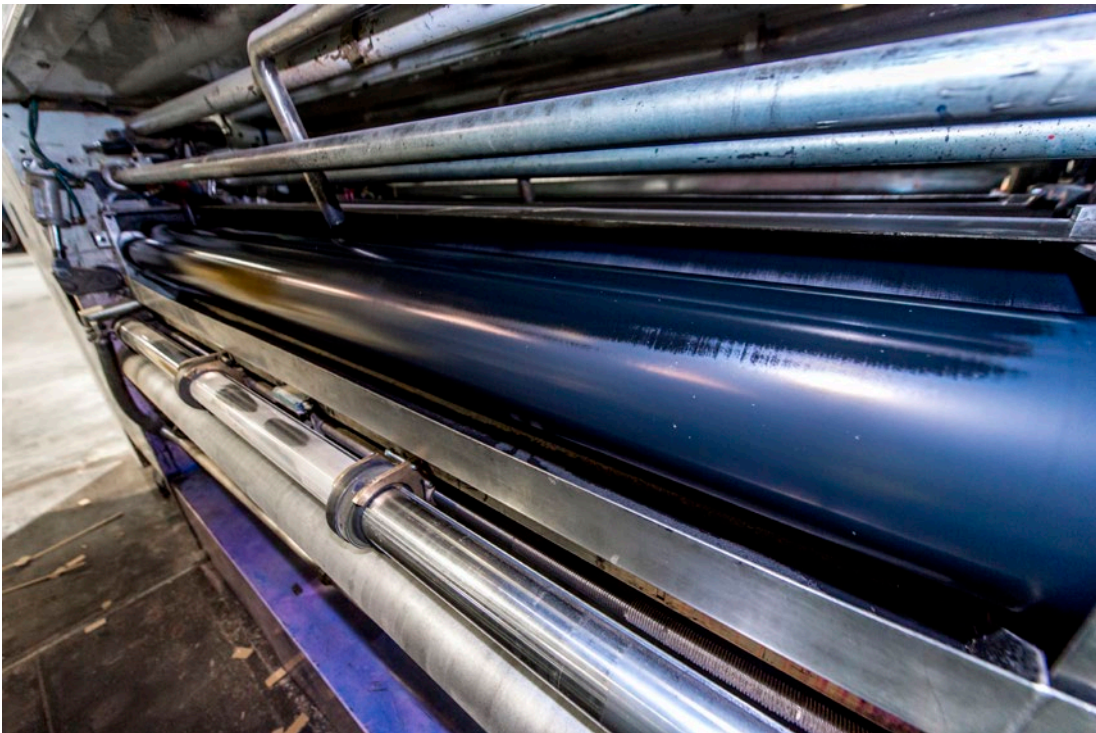

Document#	Name
0401 V1.0	Wet ink film thickness
0402 V1.0	Line count
0403 V1.0	Cell wall thickness

Screen Roll

Wet ink film thickness

1. Subject

The specifying and measuring of **wet ink film thickness** on the surface of screen rolls as used in the flexo print industry.

2. Application area

This specification can be used in the following area:

- flexo print: wet ink film thickness on the screen roll surface

3. Definition

The unit used for measuring wet ink film thickness on the screen roll surface is μm (micrometre).

The flexo industry commonly uses the unit cm^3/m^2 which is equal to μm .

In imperial measurements the unit is BCM per inch^2 ; billion cubic micrometres per square inch.

Conversion factor: $1.55 \text{ BCM}/\text{inch}^2 = 1 \mu\text{m} (\text{cm}^3/\text{m}^2)$

Ink film thickness is abbreviated to IFT. It is the wet ink film on the surface of the screen roll that is ready for transference to the substrate by the print plate.

The flexo print industry commonly refers to the ink film thickness on the surface of the screen roll as screen roll volume. The complete expression is the total volume of all cells for a given unit area.

Note that the ink film thickness on the surface of the screen roll will only be partly transferred to the substrate. It is not a value for the amount of ink printed on the surface of the substrate. TS0305: Printing, ink consumption describes how to measure the actual amount of ink transferred from the surface of the screen roll to the substrate.

How much ink is transferred from the surface of the screen roll to the substrate depends on:

- the engraved cell shape on the surface of the screen roll
- ink properties (e.g. viscosity)
- print plate properties
- substrate properties.

4. Test method

The most common test method used for measuring wet ink film thickness is as follows. Using a pipette apply a known volume of ink on the surface of the screen roll and doctor (spread) the ink over the screen roll surface. Then blot the ink on paper and measure the area of the blot. Dividing the volume of ink applied by the area measured for the blot gives an indication of the ink film thickness available on the surface of the roll.

Today the industry also commonly uses a light interferometry scanning microscope that scans the surface of a screen roll and represents it as a 3D image. Note that using the scanned surface to quantify the ink film thickness available on the screen roll requires an accurate definition of what is the bottom of the cell and the top of the cell wall.

5. Results reporting

The IFT is measured in at least three positions across the surface of the roll (operator side, centre and drive side). The table is an example of the results which include the target value and the value claimed by the supplier:

Station #	Specification	Supplier	OS	Centre	DS
1	11 μm	10.8 μm	10.0 μm	9.4 μm	8.6 μm
2	11 μm	11.2 μm	12.2 μm	11.7 μm	11.4 μm
3	11 μm	10.9 μm	9.2 μm	9.3 μm	9.2 μm

Note that measured values can differ due to, for example, rolls being dirty with ink.

The following chart shows a long term trend line for one screen roll measured over a period of time:

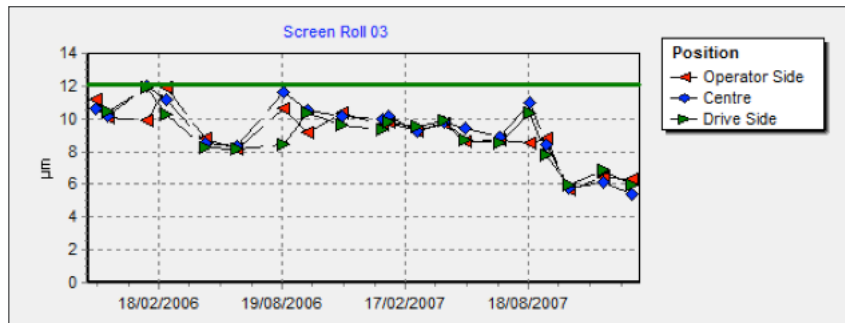

6. Target

Target levels are always agreed between customer and supplier.

Target IFT levels in relation to substrate are:

- uncoated liner: 11 μm
- coated liner: 5 μm
- film: 3 μm

References

- TS0305: Printing, ink consumption

Screen roll

Line count

1. Subject

The specifying and measuring of the **line count** on the surface of screen rolls as used in the flexo print industry.

2. Application area

This specification can be used in the following area:

- flexo print: line count on screen roll surface

3. Definition

The unit used for measuring line count on the screen roll surface is L/cm (lines per centimetre).

In imperial measurements the unit is lines per inch (LPI).

Conversion factor: 1 L/inch = 2.54 L/cm

Line count is the number of cells over a linear distance.

Line count measurement depends on whether the pattern engraved on the surface of the screen roll is square or hexagonal

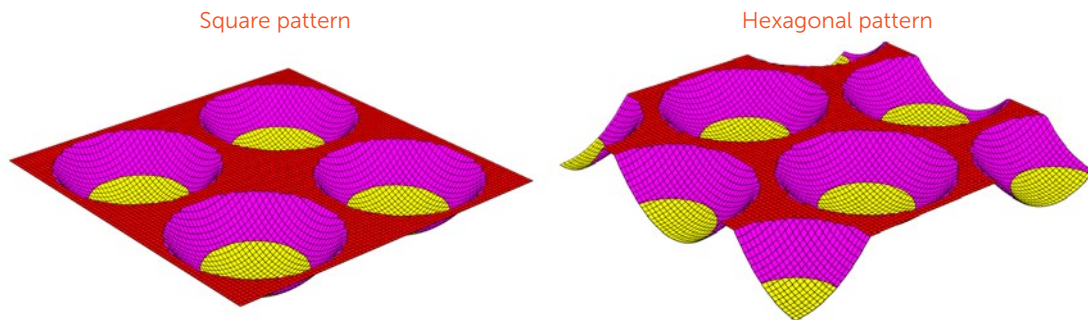

4. Test method

The screen count can be measured using an image made with a digital microscope.

The line count is measured as a line through the shortest distance between the cells as shown in the following image.

The procedure is as follows:

- Take an image of the screen roll.
- Draw a line over a number of cells as shown in the image.
- Measure the screen count: the number of lines measured divided by the distance measured. For the metric system this needs to be multiplied by 10 to get lines/cm
- The image in the example has $5 \times 10 / 0.42 = 118$ lines/cm

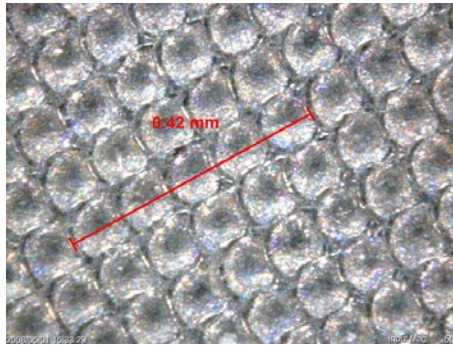

Note that the digital microscope first needs to be calibrated using a reference with a known spacing distance.

5. Results reporting

The line count is measured in one position on the surface of the roll, preferably in the centre. The table shows an example of the results including the target value:

Station #	Target value	Measured
Print station 1	100 l/cm	101 l/cm
Print station 2	100 l/cm	99 l/cm
Print station 4	100 l/cm	98 l/cm

The line count only needs to be measured once as it will not change over time.

6. Target

Target levels are always agreed between customer and supplier.

The line count needs to be defined in relation to the ink film thickness. A too high line count results in deep cells that are difficult to clean.

Target levels for line count in relation to IFT are:

- IFT: 11µm → line count: 100 l/cm
- IFT: 5 µm → line count: 180 l/cm
- IFT: 3 µm → line count: 280 l/cm

Screen roll

Cell wall thickness

1. Subject

The specifying and measuring of the **cell wall thickness** on the surface of screen rolls as used in the flexo print industry.

2. Application area

This specification can be used in the following area:

- flexo print: cell wall thickness on the screen roll surface

3. Definition

The unit used for measuring cell wall thickness on the screen roll surface is μm (micrometre).

Cell wall thickness is abbreviated to CWT. It is the thickness of the cell walls between the cells holding the ink on the surface of the screen roll.

The cell wall thickness increases during the lifetime of the screen roll and is thus a measurement of the state of the screen roll in terms of wear.

Screen rolls with the same ink film thickness (IFT) on the surface and same line count will have a different ink transfer characteristic depending on the cell wall thickness. The screen roll with wide cell walls will transfer less of the available ink on the surface. As a rule it will have deeper cells.

4. Test method

The cell wall thickness is measured using an image made with a digital microscope.

The procedure is as follows:

- Take an image of the screen roll.
- Draw a line over a cell wall as shown in the picture.
- Repeat this to get an idea of the average cell wall thickness. Notice it is around 0.010 mm which is equal to 10 μm .

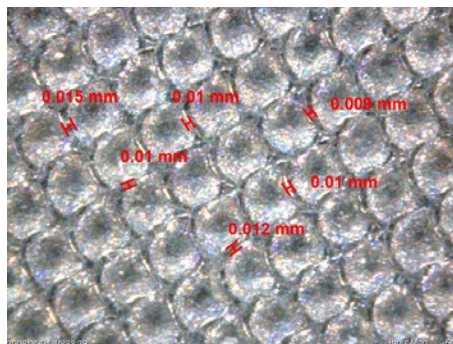

Note that the digital microscope first needs to be calibrated using a reference with a known spacing distance.

5. Results reporting

The CWT is measured in at least three positions across the surface of the roll (operator side, centre and drive side). The table below shows an example of results including the target value:

Station #	Target value	OS	Centre	DS
1	10.0 μm	10.1 μm	10.7 μm	11.4 μm
2	10.0 μm	11.1 μm	12.1 μm	11.6 μm
3	10.0 μm	13.2 μm	13.3 μm	13.5 μm

The following chart shows a long term trend line for one screen roll measured over a period of time:

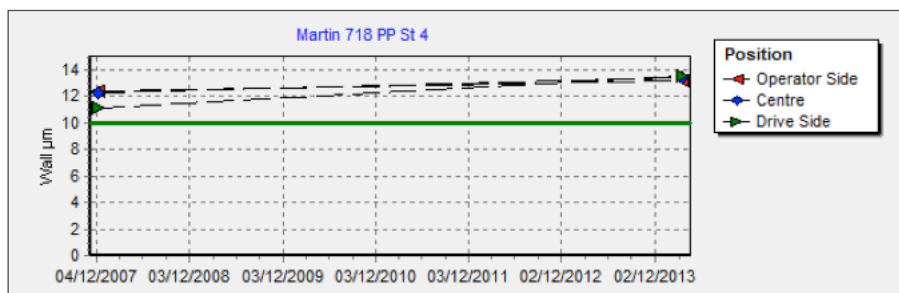

Note that the cell wall thickness increases over time.

6. Target

Target levels are always agreed between customer and supplier.

Cell wall thickness needs to be defined in relation to the line count. The higher the line count the narrower the cell walls.

Target levels for line count in relation to IFT are:

Line count: 100 l/cm → CWT: 8 μm

Line count: 180 l/cm → CWT: 5 μm

Line count: 280 l/cm → CWT: 3 μm

Slotter/Scorer



Document#	Name
0501 V1.1	Slot position relative to centre line
0502 V1.1	Slotting depth variation centre score

Slotter/scorer

Slot position relative to centre line

1. Subject

The specifying and measuring of **slot position relative to centre line** in cross production direction on the slotter/scorer part of a flexo folder gluer (FFG) as used in the corrugated packaging industry to manufacture a regular slotted case (RSC).

Part of the evaluation is also the cross production direction position evaluation of the glue lash knife and the trim knife if used. If the trim knife is not used then the glue panel side stop position of the feeder is measured.

2. Application area

This specification can be used in the following area:

- flexo folding gluing process.

3. Definition

The unit used for measuring slot position relative to centre line is mm.

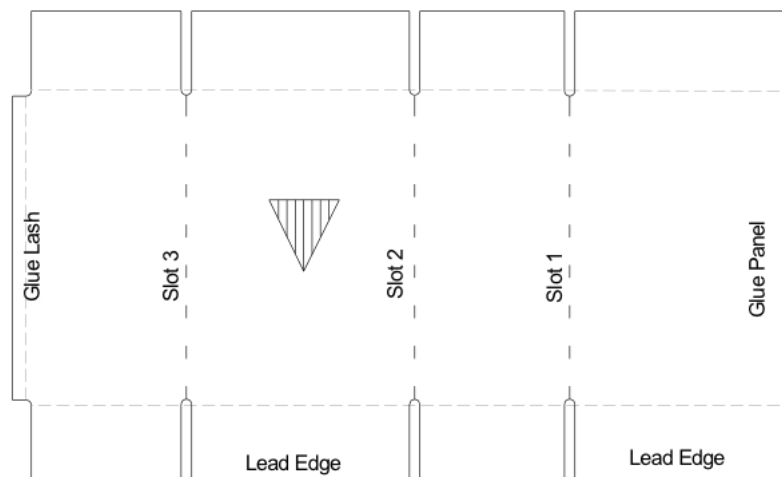

The centre slot is regarded as the 0 position, the centre line of the machine (slot 2).

Slot position relative to centre line is the cross production direction slot position, lead edge and trail edge, of slot 1, slot 3 and the glue lash relative to the centre slot (slot 2).

The glue panel board edge position is also measured relative to the centre slot. This is a value for the position of the side trim knife if used. Otherwise this is the position of the glue panel side stop of the feeder.

The slot position error is the distance between the measured relative slot position distance and the target slot position distance according to the design of the RSC.

The positions are measured using a reference print in order to mitigate the influence of board feeding. The first or last print station can be used as the reference print station (black).

Slot position variation is affected by the:

- feeding of the board
- slotting of the sheet.

4. Test method

The test can be done with or without the use of the side trim knife. If done in combination with folding it is preferable **not** to use the side trim knife.

The following RSC design (including reference print) can be used for measuring slot position relative to centre line. The design is dependent on the size of the machine.

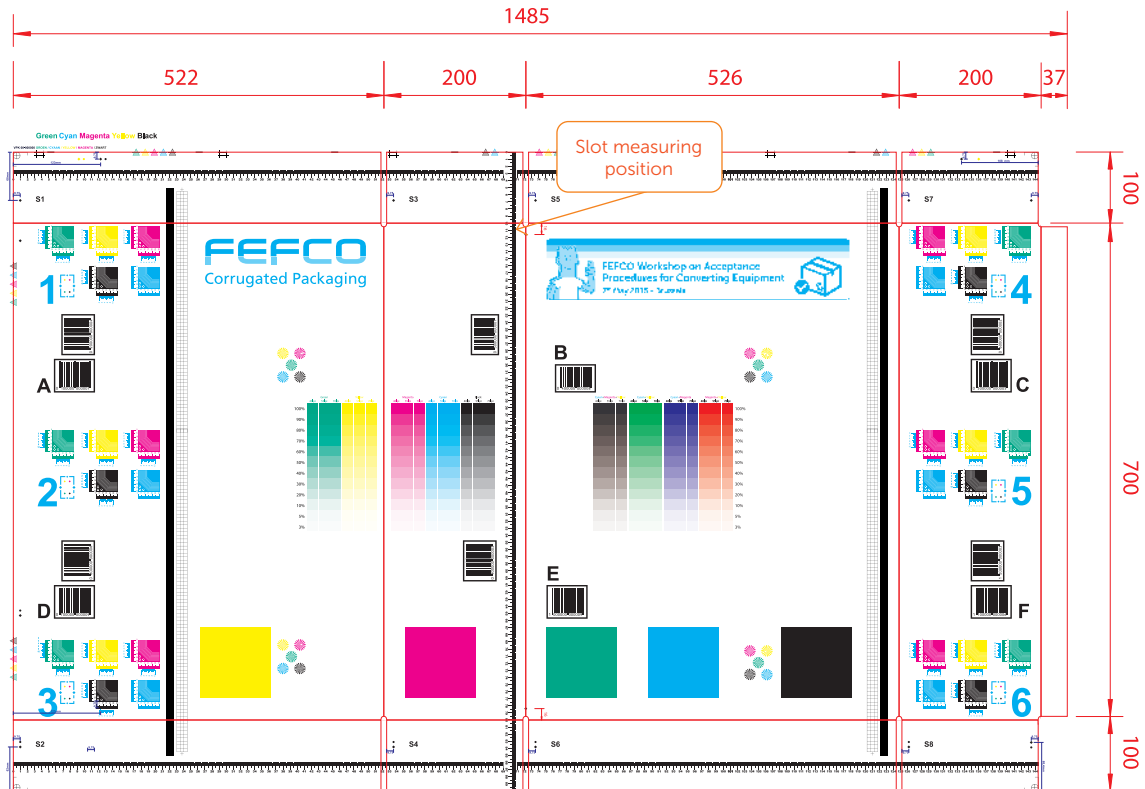

This is an enlargement of one of the areas where the cross production direction slot position is measured:

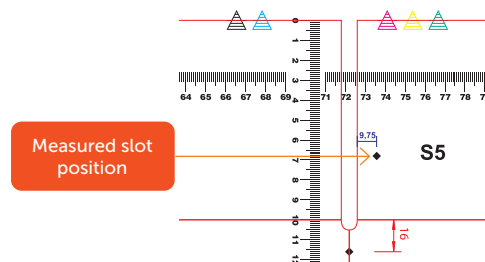

The distance between the edge of the slot and the black diamond can be measured using image analysis or a vernier. Slot distance can also be manually measured, without using a reference print, as a relative distance to the centre slot.

The design as shown has five positions on the lead edge and five positions on the trail edge.

At least 25 consecutively produced sheets should be measured in a test.

All values are recorded in a spreadsheet.

The average is calculated for the individual lead edge and trail edge centre slot (slot 2) data is measured. These average values will be used as offset values for all the individual lead edge and trail edge measured slot values.

Applying these offset values results in the centre slot values (slot 2) position around 0, the centre line of the machine.

The result is that all the data is positioned relative to slot 2 which is the centre slot.

From the lead edge and trail edge collected data is calculated for the individual slot positions:

- maximum deviation from target position
- minimum deviation from target position
- average deviation from target position
- the standard deviation of the measured values
- the skew of the slot relative to the target position.

5. Results reporting

The first part of the evaluation looks at the position of the edge of the glue panel and the glue lash. The second part of the evaluation looks at the position of the three slots.

All graphs in this example show data offset relative to the centre slot (slot 2) resulting in the data collected for the centre slot centre around 0.

The following graph and table show the results for the glue lash and glue panel edge.

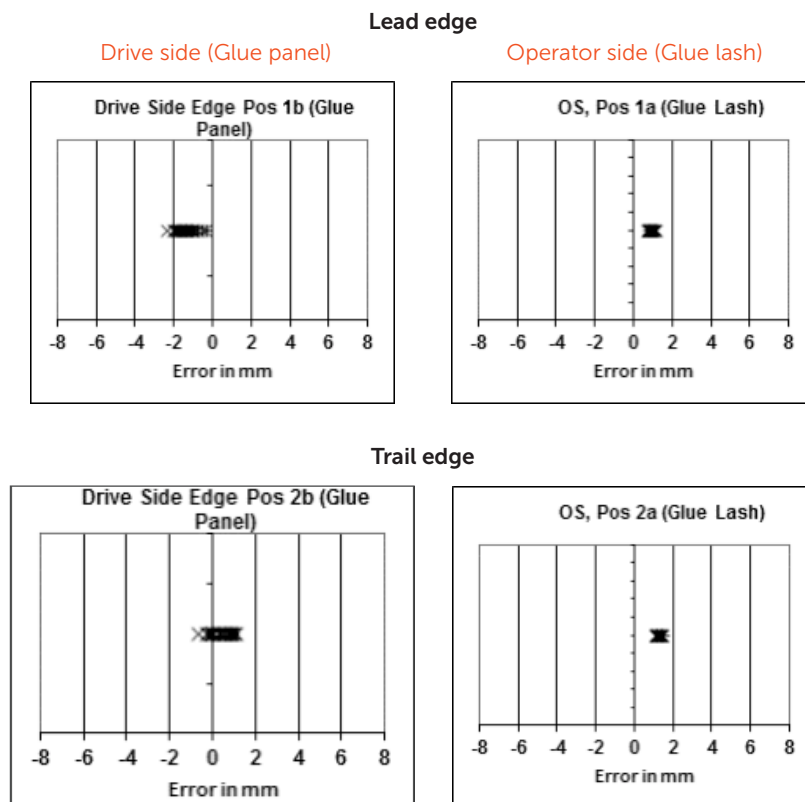

The key glue lash and glue panel measurement results are:

Glue panel	Glue lash
Max: 1.10	Max: 1.50
Min: -2.35	Min: 0.76
Avg.: -0.48	Avg.: 1.10
Std: 1.02	Std: 0.21
Avg. skew: -4.36	Avg. skew: -0.86

The following graph and table show the results for the slots.

Lead edge

Slot 1 (Glue panel)

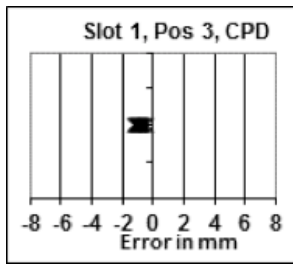

Slot 2

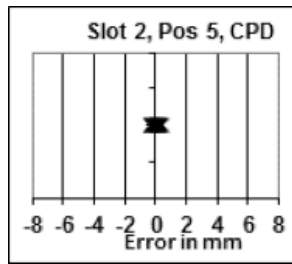

Slot 3

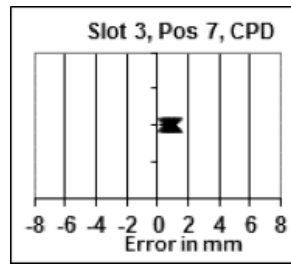

Trail edge

Slot 1 (Glue panel)

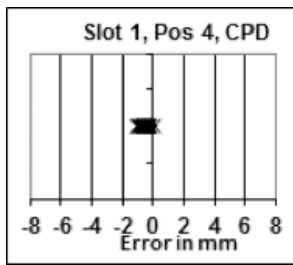

Slot 2

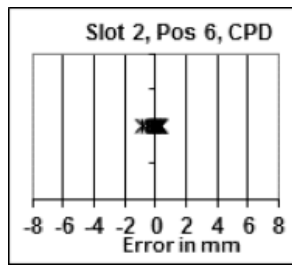

Slot 3

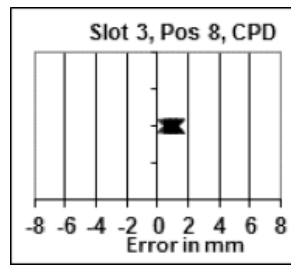

The key slot cross production direction measurement results are:

Slot 1 (glue panel)	Slot 2	Slot 3
Max: 0.03	Max: 0.47	Max: 1.28
Min: -1.18	Min: -0.93	Min: 0.43
Avg.: -0.71	Avg.: 0.00	Avg.: 0.92
Std: 0.28	Std: 0.28	Std: 0.21
Avg. skew: -0.79	Avg. skew: 0.00	Avg. skew: -0.31

6. Target

Target levels are always agreed between customer and supplier.

The target speed for running the test is 90% of the maximum machine speed.

The targets for individual slot position relative to centre line lead edge and trail edge are:

- ± 1.5 mm
- $\sigma < 0.5$ mm

Rev#	Revision	Date
1.1	Added using the first or last print station as reference	25/4/16

Slotter/scorer

Slotting depth variation centre score

1. Subject

The specifying and measuring of **slotting depth variation centre score** in production direction on the slotter/scorer part of a flexo folder gluer (FFG) as used in the corrugated packaging industry to manufacture a regular slotted case (RSC).

2. Application area

This specification can be used in the following area:

- flexo folding gluing process.

3. Definition

The unit used for measuring slotting depth centre score is mm (millimetre).

Slot depth is the depth of the slot from the lead edge or trail edge of the board.

The slot depth error is the distance between the measured relative slot depth and the target slot depth according to the design of the RSC.

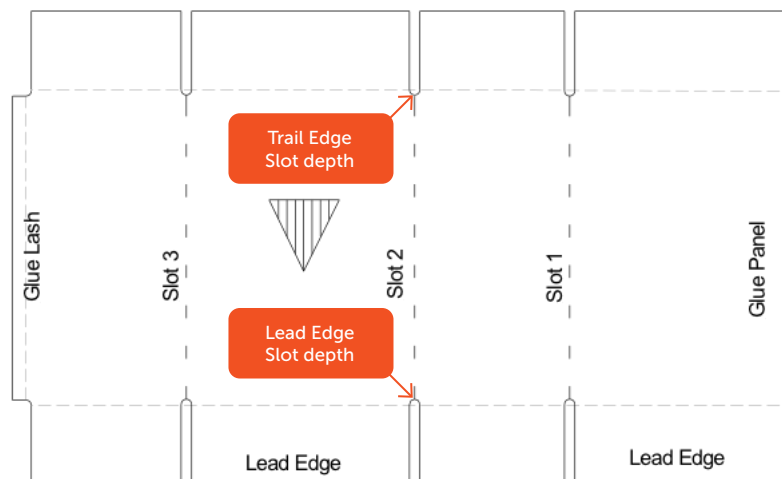

Slot depth is measured for the centre slot (slot 2) relative to a printed ruler using the first or last print station. This to remove the influence of feeding of the board on slot depth variation.

The measurement of feeder accuracy is described in TS0201: Feeding, feed to first register PD/CPD variation. The first or last print station can be used as the reference print station (black).

Slot position variation is affected by the:

- feeding of the board
- slotting of the sheet.

4. Test method

The following RSC design (including reference print) can be used for measuring slot depth. The design is dependent on the size of the machine.

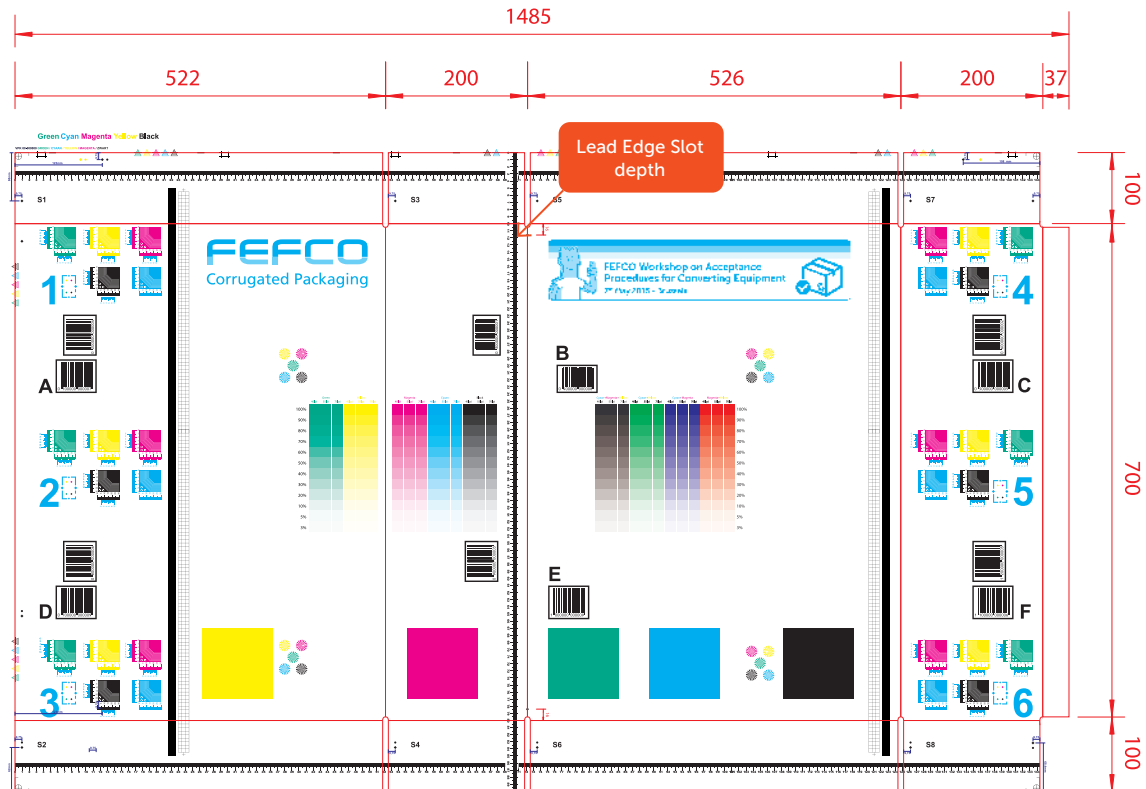

This is an enlargement of the area where the slot depth is measured:

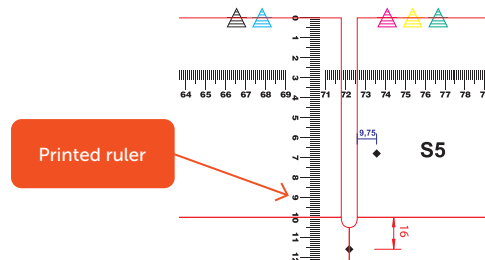

The slot depth is manually measured with the printed ruler from print station one. In the design the nominal slot depth is 12 mm (16-4).

The slot depth is measured for lead edge and trail edge.

At least 25 consecutively produced sheets should be measured in the test.

The error between the target slot depth and the actual slot depth is shown in a graph for the lead edge and the trail edge.

The following is calculated from the lead edge and trail edge slot depth data:

- maximum deviation of slot depth
- minimum deviation of slot depth
- average deviation of slot depth
- the standard deviation of the measured values.

5. Results reporting

The following is an example of reporting slot depth results.

The following charts show the print direction slot depth variation of slot 2:

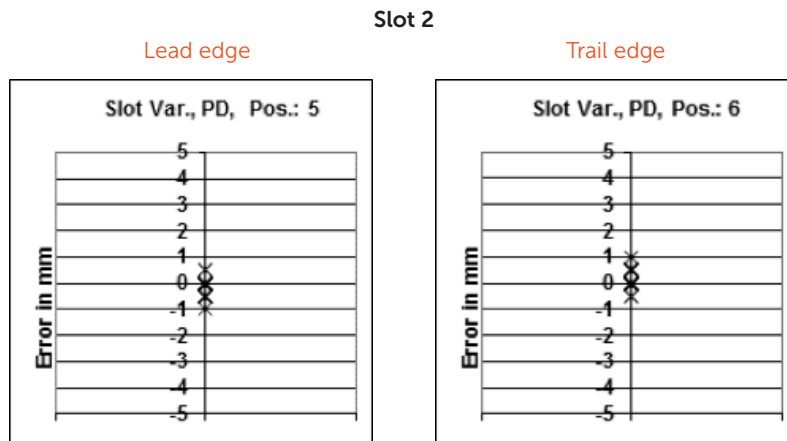

The slot 2 depth measurement results in print direction are as follows:

	Slot 2
PD	Max: 1.00
	Min: -1.00
	Avg.: 0.03
	Std: 0.40

6. Target

Target levels are always agreed between customer and supplier.

The target speed for running the test is 90% of the maximum machine speed.

The targets for slot depth lead edge and trail edge are:

- ± 1.5 mm
- $\sigma < 0.5$ mm Target levels are always agreed between customer and supplier.

References

TS0201: Feeding, feed to first register PD/CPD variation

Rev#	Revision	Date
1.1	Added using the first or last print station as reference	25/4/16

Die Cutting



Document#	Name
0601 V1.0	Print to die cut register variation
0602 V1.0	Scoring depth variation
0603 V1.0	Tray length variation
0604 V1.0	Waste removal

Die cutter

Print to die cut register variation

1. Subject

The specifying and measuring of **register** and **register variation** as used in the print/die cut packaging industry.

2. Application area

This specification can be used in the following area:

- print to die cut register.

The specification can be applied to any print to die cut production method: flexo, offset, screen, gravure, digital, etc.

3. Definition

The unit used for measuring print to die cut register is mm (millimetre).

Print to die cut registration error is the distance between one printed and one die cut element that had the same position in the original.

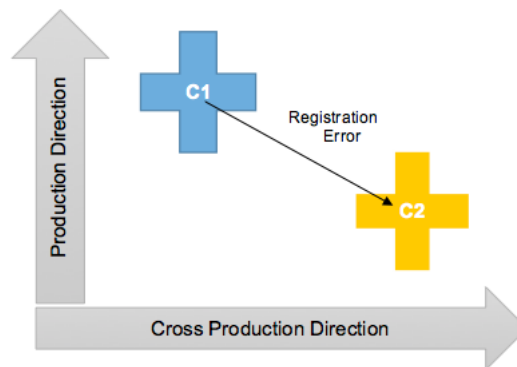

Above is an illustration of the registration error. Print to die cut register is two dimensional. A value needs to be measured for production direction (PD) and cross production direction (CPD).

The registration error is a distance. The following equation is used to calculate the registration error distance from the measured PD and CPD data:

$$R_{\text{error}} = \sqrt{PD_{\text{error}}^2 + CPD_{\text{error}}^2}$$

R_{error} = Distance between two positions

PD_{error} = Production direction distance between two positions

CPD_{error} = Cross production direction distance between two positions

The value for the print to die cut registration error is quantified as the standard deviation for all production direction values and cross production direction values separately. A value for the print to die cut registration spread can be computed by adding both values together in accordance with the general rule for adding errors:

$$\sigma_{\text{total}} = \sqrt{\sigma_{PD}^2 + \sigma_{CPD}^2}$$

σ_{total} = Total statistical print to die cut registration error

σ_{PD} = Standard deviation of the production direction print to die cut registration

σ_{CPD} = Standard deviation of the cross production direction print to die cut registration

The following is an illustration of the register error between print to die cut:

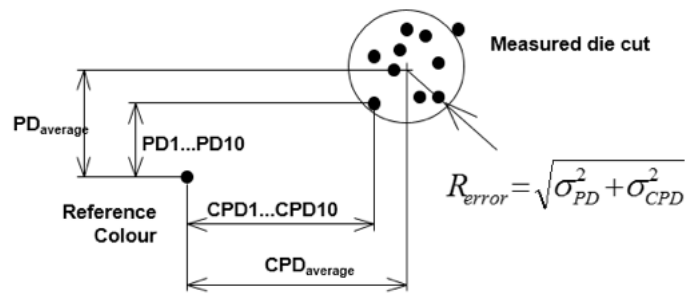

4. Test method

A specially designed test form and die cut form is used that holds the elements in their designated positions which allows for the measuring of the register error using image analysis. The following is a design example.



Element for using image analysis

In the print, the print to die cut register is measured in at least two positions, preferably in diagonal corners on the evaluated print/die cut. This should be done on at least 10 consecutive sheets. A more accurate measurement will result if six positions are used. The register is measured between the reference print and die cut.

The collected data can be corrected for the following systematic errors:

- offset register
- stretching (production direction and cross production direction)
- skewing between print and die cut (mostly linked to tool mounting).

5. Results reporting

The measured register data can be presented as shown in the following graph where all measured data on all sheets in all positions are shown in one graph:

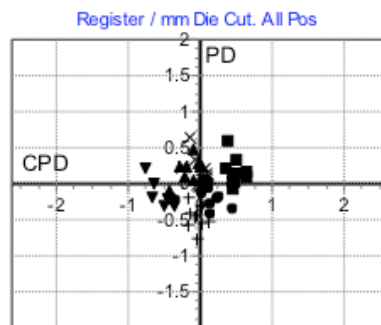

The standard deviation is calculated by direction (CPD and PD) and added up using this equation:

$$\sigma_{total} = \sqrt{\sigma_{PD}^2 + \sigma_{CPD}^2}$$

Results can also be shown (and calculated) by position:

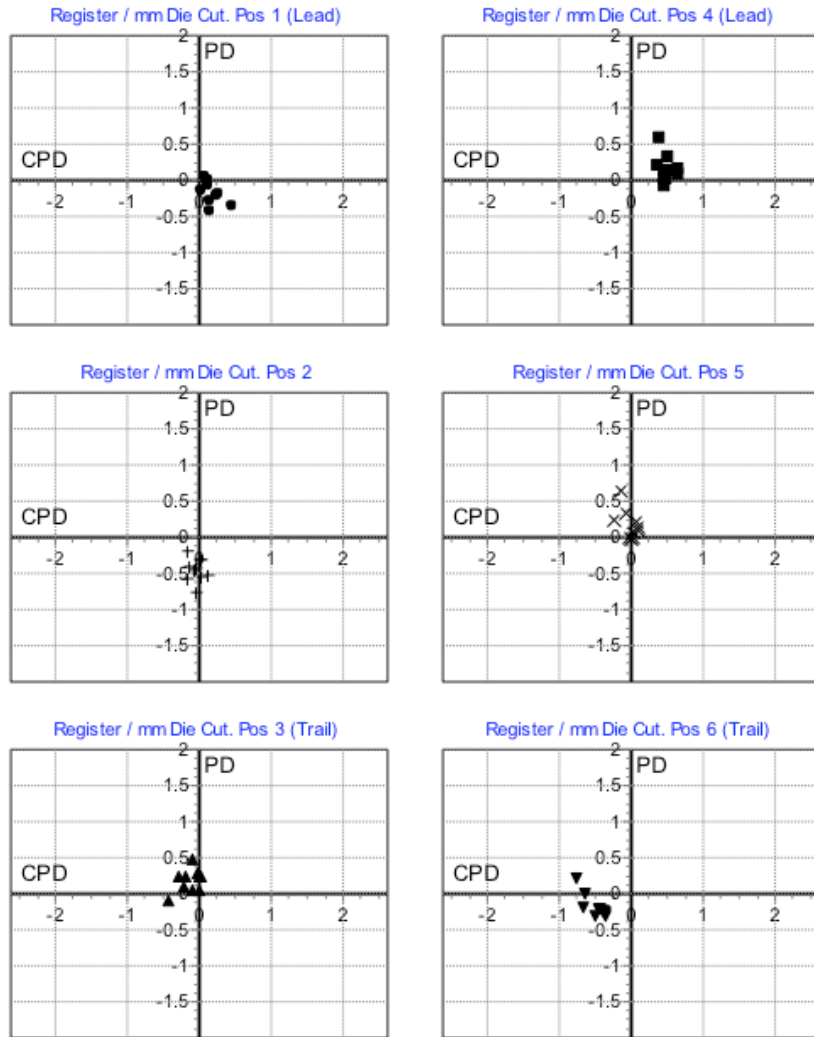

6. Target

Target levels are always agreed between customer and supplier. A range can be defined as the register error radius of a circle in which all measured register values are positioned.

The target speed for running the test is 90% of the maximum machine speed.

Depending on the production method used the data is corrected for non-machine errors, for example, offset, stretch and skew in case of machine acceptance.

The test provides a value for the standard deviation of the measured values. Three times the standard deviation (3σ) of the test is < than the agreed range (radius) value. 3σ represents in this case 99.7% of the data population evaluated. Thus if 3σ is equal to the agreed register error radius it means that 99.7 % of the measured data is within the agreed register error radius.

The following image shows the relation between the test results and the agreed register error radius (1.50 mm) as a red circle:

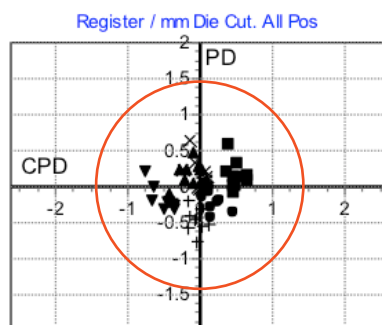

Typical register standard deviation values for print to die cut register after correction for offset, stretch and skew are:

- rotary die cutting: $\sigma < 0.5 \rightarrow$ register error radius: 1.50 mm
- flat bed die cutting: $\sigma < 0.5 \rightarrow$ register error radius: 1.50 mm

Die cutter

Scoring depth variation

1. Subject

The specifying and measuring of scoring depth variation during die cutting and/or slotting and scoring of corrugated sheets as used in the corrugated packaging industry.

2. Application area

This specification can be used in the following areas:

- rotary die cutting
- flatbed die cutting
- slotting and scoring as part of the flexo folding gluing process.

3. Definition

The unit used for measuring scoring depth is mm (millimetre).

Scoring depth error is the score depth difference of an individual score relative to the average score depth of all scored parts of the population evaluated.

Scoring depth variation is the standard deviation of all scoring depth errors measured.

The score depth needs to be uniform over the full sheet. Score depth evaluation provides information about the gap setting between die cut tool and anvil. This is affected by, for example, the anvil diameter uniformity (rotary die cutting).

The same measuring method can be applied to rotary die cutting, flatbed die cutting and scoring in a flexo folder gluer.

4. Test method

For the scoring depth evaluation at least 10 sheets are die cut and collected where trays from a single sheet are not separated. The cross production direction score depth is measured in at least six positions per die cut sheet as indicated in the following example test.

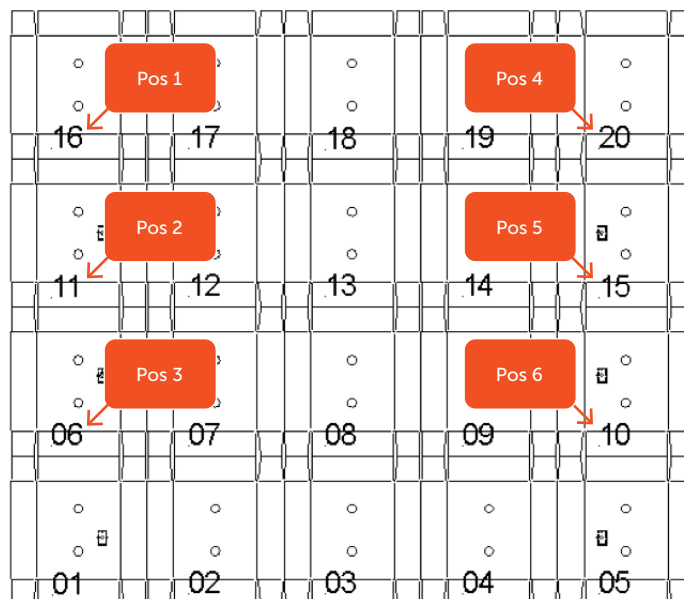



From the die cut trays the scoring depth is scanned and from the scan the maximum depth is measured. This can be done using a non-contact laser depth sensor with a resolution of 4 μm as shown (Baumer distance sensor: OADM 12I6430/S35A) in combination with a 16 bit AD convertor.

The data is collected in a spreadsheet for evaluation.

5. Results reporting

The score depth is, for example, scanned in six positions on 10 sheets and the score depth measured from these scans results in 60 score depth measurements.

The score profile of a single scan is shown on the right.

The 60 score depth values derived from the scans can be presented in a histogram as shown.

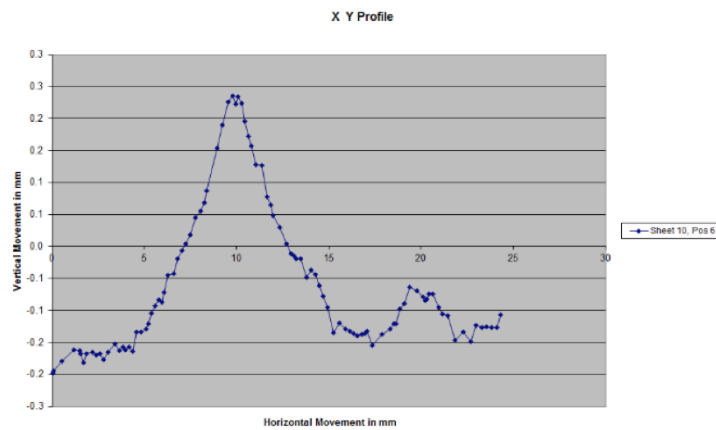

The score depth standard deviation can be calculated from the score depth values derived from the scans. The score depth standard deviation value calculated from the depth values used for the histogram is $\sigma < 0.06$ mm.

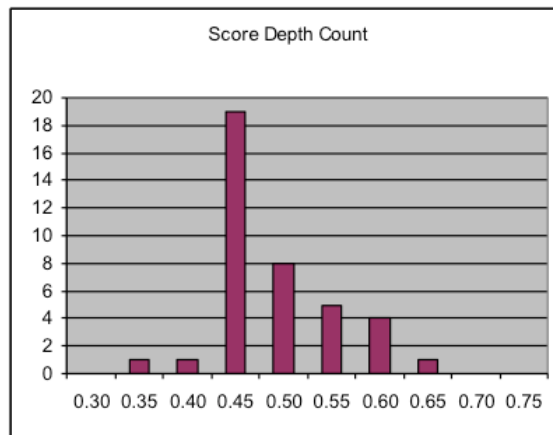

6. Target

Target levels are always agreed between customer and supplier.

The target speed for running the test is 90% of the maximum machine speed.

The proposed target for the scoring depth variation independent of die cut process is: $\sigma < 0.10$ mm

This target means that the scoring depth difference between an individual score and the average score depth can be ± 0.30 mm, meaning that two score depths can differ 0.6 mm in depth.

Die cutter

Tray length variation

1. Subject

The specifying and measuring of **tray length variation** during die cutting of corrugated sheets as used in the corrugated packaging industry.

2. Application area

This specification can be used in the following areas:

- rotary die cutting
- flatbed die cutting.

3. Definition

The unit used for measuring tray length is mm (millimetre).

The tray length is measured in production direction only.

Tray length error is the difference in length of an individual tray relative to the average tray length of all trays in the population evaluated.

Tray length variation is the standard deviation of all tray length errors measured.

The tray length variation provides information on the uniformity of die cutting in production direction. This uniformity is influenced by factors such as the anvil diameter uniformity (rotary die cutting) and the speed differential between anvil and cutting tool.

The same measuring method can be applied to rotary and flatbed die cutting.

4. Test method

Die cut length variation is measured by die cutting a tray. The design can differ depending on the size of the machine. The following diagram shows a four up and five across cutting die which is typical for a 66 inch rotary die cutter.

The board used for the test needs to be produced at least 12 hours before running the test.

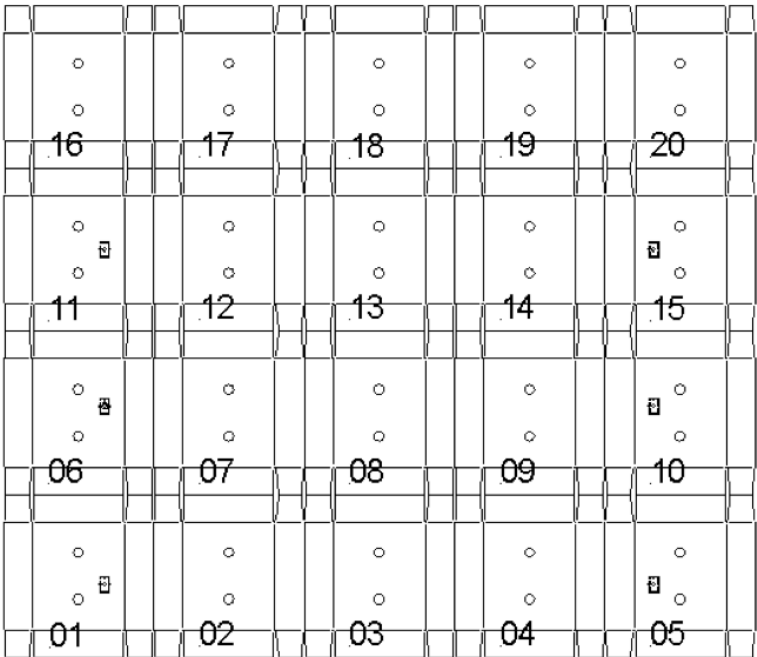

The tray length in production direction of, in this case, five columns of four trays is measured on at least 10 consecutively die-cut sheets. In this case the trays are numbered 1-20.



The tray length is measured using a digital dial indicator with an interval of 0.001 mm and positioned in a holder that can hold the tray as shown in the sketch below.

All data is collected using a spreadsheet where the tray length is entered for the individual trays by die cut sheet and position.

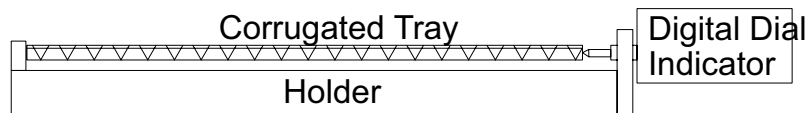

5. Results reporting

For the tray length evaluation at least 10 sheets are die cut and collected as sheets where the individual trays from a single sheet are not separated.

The individual trays are marked with the sheet number before separating the individual trays in that sheet.

The data is measured and recorded in a spreadsheet.

The die cut length variation data of all measurements are shown in one graph and by row. The following table shows the results of a die cut test where a die was used with five columns of three trays up. The standard deviation for all measurements and by row is shown.

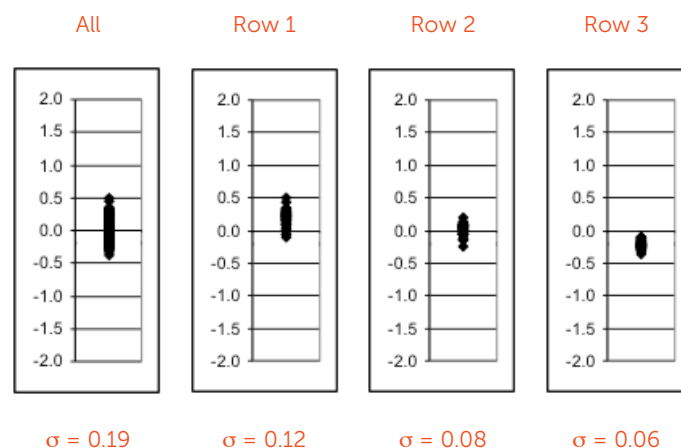

The next diagram shows for the same test the tray length for the individual sheets and for all sheets in a row and column.

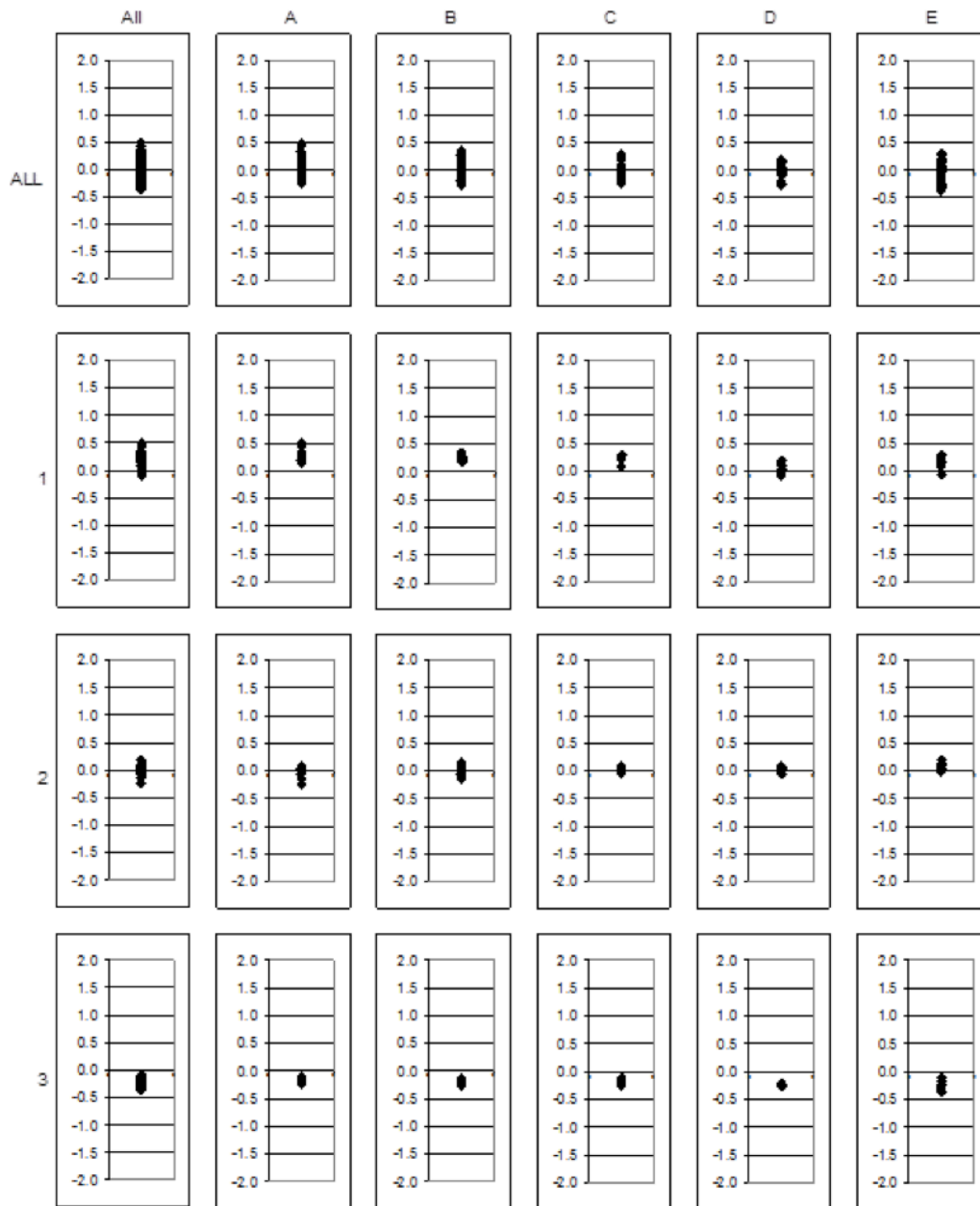

6. Target

Target levels are always agreed between customer and supplier.

The target speed for running the test is 90% of the maximum machine speed.

The proposed target for the tray length variation independent of die cut process is: $\sigma < 0.25$ mm

This target means that the tray length difference between an individual tray and the average tray can be ± 0.75 mm, meaning that two trays can differ 1.5 mm in length.

Die cutter

Waste removal

1. Subject

The specifying and measuring of **waste removal** during die cutting and/or slotting scoring of corrugated sheets as used in the corrugated packaging industry.

2. Application area

This specification can be used in the following areas:

- rotary die cutting
- flatbed die cutting
- slotting and scoring as part of the flexo folding gluing process.

3. Definition

The unit used for measuring waste removal is the percentage of unremoved waste (waste between finished products) of the total waste to be removed.

100% indicates that all waste has been removed and no waste is left between the finished products.

Predictable waste is generated during the die cutting and/or slotting scoring of corrugated sheets.

The predictable waste is the difference in weight between the finished products cut from the sheet and the total weight of the sheet at the start of the cutting and/or slotting process.

The aim is that all predicted waste is removed and does not end up between the stack of finished products.

The predicted amount of waste to be removed is:

- The weight of the sheet the product is made from minus the weight of the finished product.

The predicted waste that is not removed is:

- The weight of a defined stack of die cut products minus the predicted weight for that stack of die cut products.

Waste removal percentage is:

- 100% minus the predicted waste that is not removed divided by the predicted waste to be removed*100%.

The removal of waste depends on:

- the design of the product made
- the cutting tool
- the production machine.

It is important to use a standard product design for measuring waste removal.

4. Test method

The following is an example of measuring waste removal from a die cut form for rotary or flatbed die cutting. The die cut form consists of 20 identical trays.

○		○		○		○	
○		○		○		○	
16		17		18		19	20
○		○		○		○	○
○		○		○		○	○
11		12		13		14	15
○		○		○		○	○
○		○		○		○	○
06		07		08		09	10
○		○		○		○	○
○		○		○		○	○
01		02		03		04	05

Test procedure:

1. Measure the weight of a pre-set stack of sheets used for the die cut test e.g. 50.
2. Start the die cut test and produce sheets. Separate a stack of, for example, 50 sheets as a single stack. Make sure that waste collected between the sheets stays between the sheets.
3. Measure the weight of the stack of the produced product.
4. Count the number of sheets in the stack.
5. Take, for example, 10 sheets of die cut product and remove all die cut waste.
6. Measure the net weight of the 10 die cut sheets (in this case 200 products).
7. Calculate the waste removal percentage.

Note that all values need to be standardized to one sheet.

Waste removal percentage equation:

$$\text{Waste removal \%} = \left(1 - \frac{\frac{\text{actual weight stack}}{\text{number of sheets in stack}} - \text{weight of end product}}{\text{weight of sheet} - \text{weight of end product}} \right) * 100\%$$

Weight of sheet = weight of single sheet in g

Weight of end product = the total product weight made from one sheet in g

Actual weight of stack = the total weight of the stack produced during the test in g

Number of sheets in stack = number of sheets used for producing end product

5. Results reporting

The results can be reported as a percentage indicating the number of sheets produced in the test as shown in the following table:

TestID	#Sheets	Waste removal %
1	100	98%
2	200	99%

6. Target

Target levels are always agreed between customer and supplier.

The target speed for running the test is 90% of the maximum machine speed.

The target level for waste removal is 99.9%.

Folding

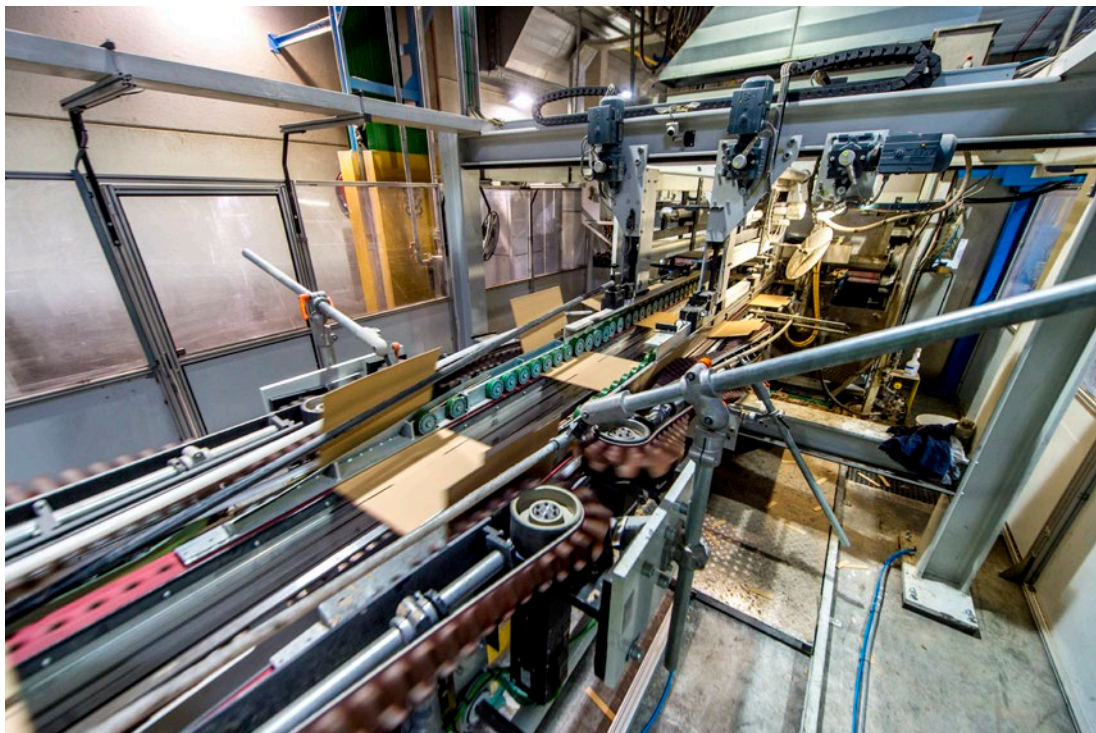

Document#	Name
0701 V1.0	Glue consumption
0702 V1.1	Fishtailing & Gap variation
0704 V1.0	Folding torque in relation to depth
0705 V1.0	Number of stitches
0706 V1.0	Tape consumption
0707 V1.0	Waste inside folding section

Folding

Glue consumption

1. Subject

The specifying and measuring of **glue consumption** in relation to machine speed on a flexo folder gluer (FFG) as used in the corrugated packaging industry to manufacture a regular slotted case (RSC).

2. Application area

This specification can be used in the following area:

- flexo folding gluing process.

3. Definition

The unit used for measuring glue consumption is g/m.

Glue consumption is the amount of glue in grams transferred per sheet from the glue container to the glue lash of the RSC.

Glue consumption is standardized for the length of the glue lash. The glue consumption in g/sheet divided by the length of the glue lash results in glue consumption in g/m.

Glue consumption depends on the glue type and equipment used.

4. Test method

Glue consumption is measured by putting the glue tub (reservoir) on a scale and positioning a sensor inside the machine recording sheets passing through the machine.

The value on the scale is recorded every time a sheet is detected.

Every time a sheet is detected and the weight is detected by the scale, the sheet count and time is recorded.

The recording of a scale value is dependent on the scale being ready to send a value to the computer. Scales are often relatively slow. It can therefore happen that at high speed two out of three detected sheets will have a scale reading.

Glue consumption is the slope of a linear regression curve through all collected data points. It is calculated by applying a linear regression function on all glue consumption data points for the individual tests. The slope of the linear regression curve is calculated using the following equation:

$$b = \frac{\sum (x - \bar{x}) * (y - \bar{y})}{\sum (x - \bar{x})^2}$$

\bar{b} = glue consumption in g/sheet
 \bar{x} = sheet number
 \bar{x} = average sheet number
 \bar{y} = glue weight for given sheet
 \bar{y} = average glue weight for given sheet

The slope value calculated from the collected glue consumption data will have a negative sign.

The sheet detection data provides information about machine speed.

Glue consumption (in g/m) is calculated using the following equation:

$$\text{Glue consumption g/m} = \frac{\text{Glue consumption in g/sheet}}{\text{Glue lash length in m}}$$

Glue consumption can be measured during standard production. The test is done by producing at least 1,000 products.

It is important that individual tests are done while running different production speeds in order to investigate if the glue system transfers the same amount of glue in g/m independent of machine speed.

5. Results reporting

Glue consumption tests are done using at least three different production speeds.

The first step in the measurement of glue consumption shows the data collected in two graphs, one for glue consumption and one for machine speed.

Glue consumption

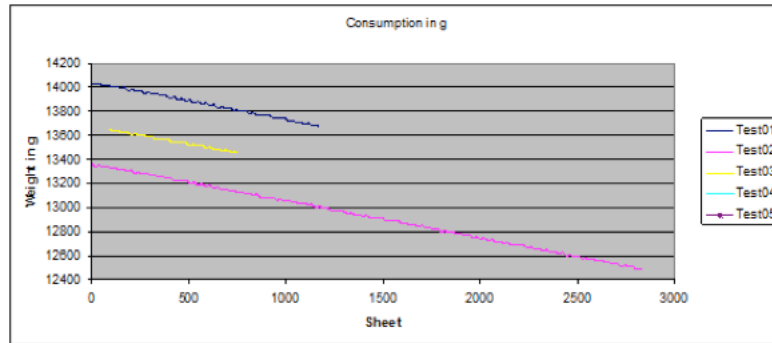

Speed

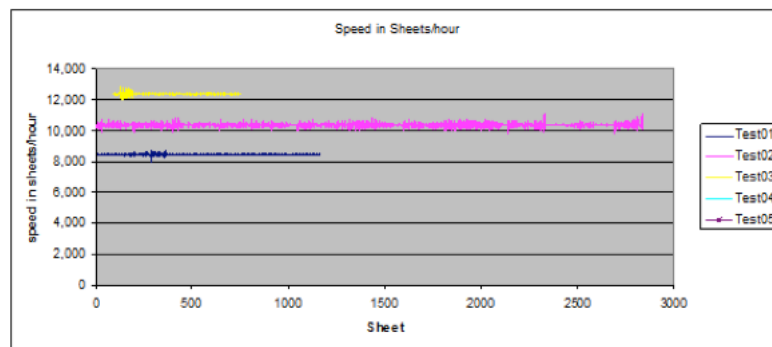

The results of the three tests above are shown in the following table:

Test#	Glue lash length in mm	#sheets test	Speed sht/h	Glue consumption in mg/sheet	Glue consumption in g/m (glue lash length)
1	213	1164	8,455	308	1.45
2	213	2830	10,353	309	1.45
3	213	659	12,374	283	1.33

The test results are shown in a glue consumption speed graph:

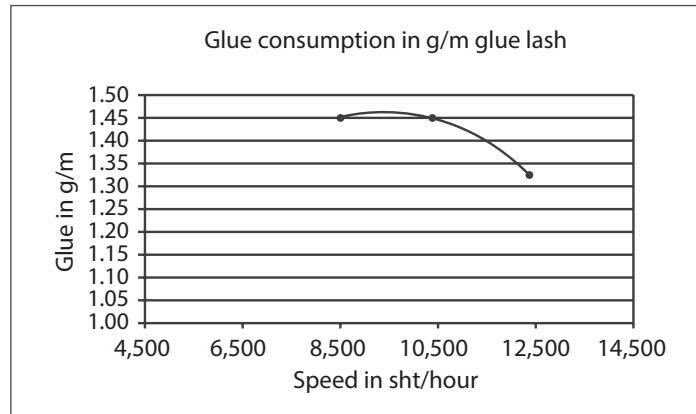

These test results show that glue consumption is minimally lower at higher speed.

6. Target

Target levels are always agreed between customer and supplier.

The target speeds for running the tests are 50%, 70% and 90% of the maximum machine speed.

Glue consumption should be: 1.0- 1.5 g/m \pm 0.2 g/m

Glue consumption should be constant regardless of machine speed.

Folding

Fishtailing & Gap variation

1. Subject

The specifying and measuring of gap and fishtailing on a flexo folder gluer (FFG) as used in the corrugated packaging industry to manufacture a regular slotted case (RSC). Regarding the validity for a die-cutted case, see 4.2.

2. Application area

This specification can be used in the following area:

- flexo folding gluing process.

3. Definition

3.1. Dimensions

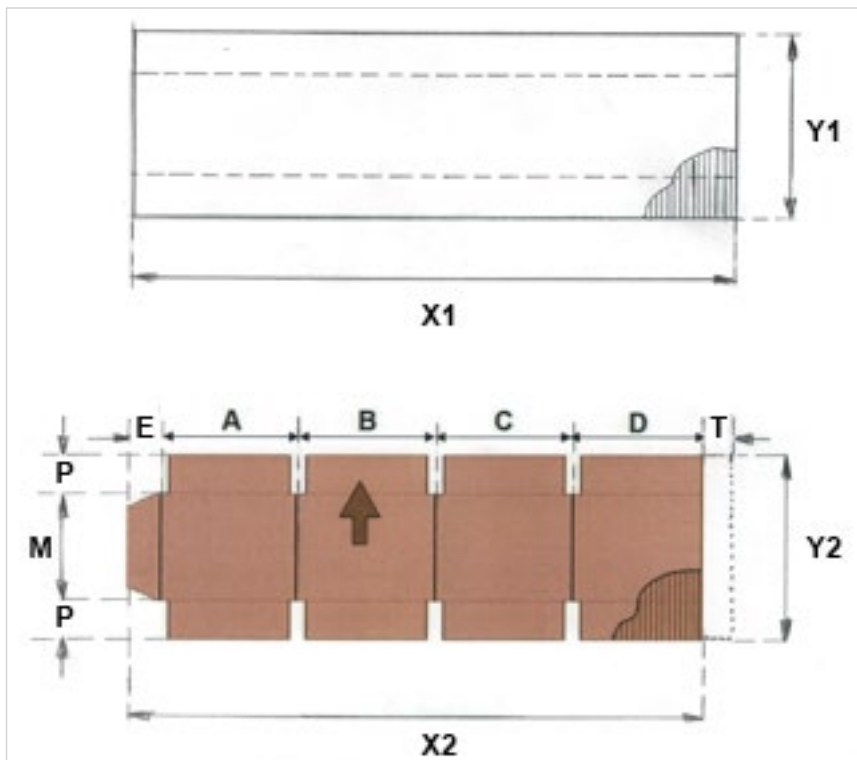

Legend

A, B, C, D	Panels length / width
E	Flap length
M	Height
T	Side trim length
X1 =	X2 + T
Y1 =	Y2
X2 =	E + A + B + C + D
Y2 =	2P + M
K	Caliper (not visible in the above drawing)

3.2. Gap and Fishtailing

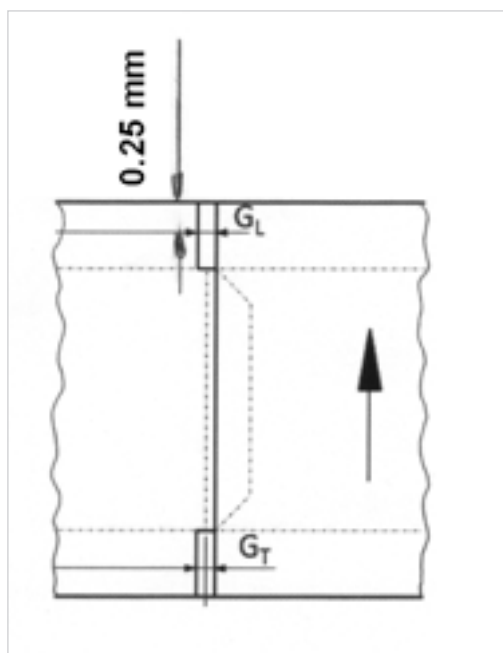

Legend

GL	Leading gap
GT	Trail gap

Gap G

The variation of the gaps G_L and G_T is the variation of the space between the edges of the two folded panels as indicated in the drawing above. The measuring position has to be in the range of 0 to 25 mm from the outer edge and the same for G_L and G_T .

Fishtailing F

Fishtailing as faulty parallelism between the edges of the two folded panels is defined as the difference between the leading gap G_L and the trail gap G_T of the same piece. G_L and G_T are measured as indicated in the drawing above.

4. Test method

4.1. Board parameters and condition

The following board parameters must be documented for every acceptance test:

- board type / name,
- board composition: grammage and type of every paper,
- ratio of grammage between inner liner and fluting, ratio of grammage between outer and inner liner (calculated values),
- dimensions X_1 and Y_1 (measured at the beginning of the test),
- nominal and real caliper (real caliper measured at the beginning of the test),
- absolute humidity (sampled within the upper third of the stack in front of the machine, but not the first 10 sheets from above; taking samples at the beginning of the test).

Note: board type, board composition and nominal caliper are essential parameters for the reachable tolerances and are therefore also required for the evaluation by the machine supplier.

The board must be glued properly, not delaminated, the edges accurately cut and not crushed. Boards with surface treatment (water repellent, anti-skid coating) and sheets printed before the FFG should not be used for acceptance tests.

The following conditions and board parameters must be kept and documented for every acceptance test:

- absolute humidity of the board 6% - 10 %.
- converting soonest 8 hours after the production at the corrugator.
- board warp H maximum 2 % of Y1 for up- and downwarp. See FEFCO Recommendation No. 110 for further details including the measurement method. Chord L can be replaced by Y1.

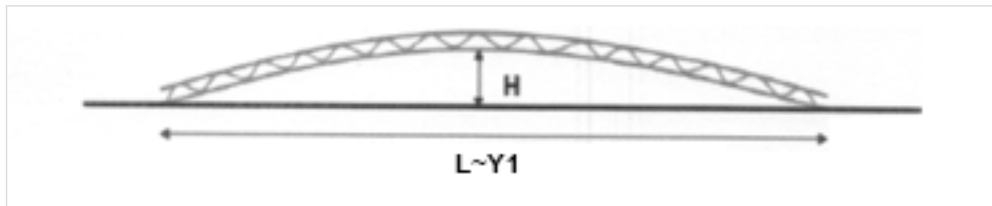

It is not recommended to use twisted sheets or sheets with an even warp or warp in cross running direction. They can be used only with acceptance of the supplier and the customer and must be documented.

4.2. Test execution

The requirements for acceptance tests are:

- side trim T is mandatory (minimum for 8 mm single wall, minimum 10 mm for double wall),
- the setup of the Inline machine has to be done with the measured real caliper,
- correctly maintained machine with all tooling as per machine suppliers specification and instruction,
- operation with skilled operators,
- all sheets from the same stack.

An acceptance test consists of minimum 3, typically 5 different articles of a regular slotted case. A die-cutted case can be part of an acceptance test if mutually agreed.

The machine speed is agreed upon every individual article between customer and supplier. This machine speed is the common basis for the promised quality and performance figures. If further tests at other speeds are done, the corresponding quality figures should be documented.

The setup of the machine and the test execution has to be documented in a report, containing the following topics:

- general information: date and place of the acceptance test, inspector's name, type and serial no. of the machine, name/ drawing-no. of the tested article with drawing,
- list of the used measuring devices for board dimension, caliper, warp, board humidity and gap,
- documentation according to 4.1. - board parameters and condition,
- setup of the machine: part no. and/ or drawing of the machine score, scoring depth, usage of precreasing and/ or humidity conditioning of the scoring line, printout or pictures of the setup parameters,
- machine speed,
- any other information which may assist in the evaluation.

FEFCO provides a report template for the documentation, the data input and the calculations of an acceptance test.

4.3. Sampling and measurement procedure

A sample consists of typical 100 and at least 50 individual consecutive pieces. The individual pieces have to be marked in ascending order. For traceability, immediate marking of GL of every first piece of a bundle (taking into account up- or downstacking) and the numbering of the bundles directly at the machine is required.

The gaps GL and GT of each individual piece are measured according to 3.2. The resolution of the measuring device has to be 0.1 mm or better and a calibration must be possible. The ratio of the specified tolerance of GL and GT divided by the standard deviation of the measuring device must be minimum 30 and should be verified by a measuring device capability test. FEFCO recommends the following measurement devices:

- mechanical measuring devices specially adapted for gap measuring (examples see photos in the appendix)
- optical/ laser measuring devices specially adapted for gap measuring (example see photo in the appendix).

The values of GL and GT and calculated Fishtailing F of each individual piece are entered in ascending order of the pieces into a list for further analysis according to 5. Using the FEFCO report template, the values of GL and GT are entered in the sheet "Measurements". Fishtailing F is calculated by the template.

The sample is stored for possible further measurements minimum four weeks.

5. Results reporting

The FEFCO report template contains the following values and calculations for GL, GT and F:

- specification: target (nominal) value, lower specification limit, upper specification limit, tolerance,
- test on normal distribution, outliers and independent measurements,
- arithmetic mean, arithmetic mean minus target, median, minimum value, maximum value, range, standard deviation,
- parts of nonconformity,
- potential machine performance Pm and machine performance Pmk including the confidence intervals based on a confidence level of 95 %,
- and as a summary if selected values of Pm and Pmk are met.

6. Target

Target levels are always agreed between customer and supplier for each individual article or a group of articles and have to include the tolerance and the statistic parameters. The following target levels should be defined:

- gap tolerance as the difference between the gap of the individual piece and the average (arithmetic mean) gap of all pieces of a sample, separately for GL and GT, or the gap tolerance as the difference between the gap of the individual piece and the target (nominal) gap value, separately for GL and GT,
- tolerance of fishtailing F as the difference between the fishtailing of the individual piece and the target (nominal) value of 0 mm.

Appendix

Examples of mechanical measuring devices specially adapted for gap measuring

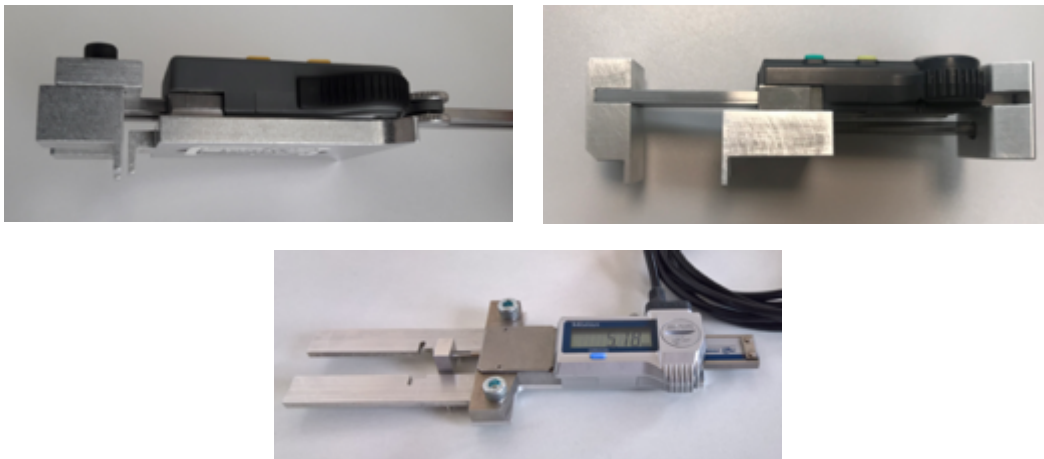

Example of an optical/ laser measuring device specially adapted for gap measuring



References

Rev#	Revision	Date
1.2	TS 702 and TS 703 combined with the one technical specification and updated	10/10/2019

Folding

Folding torque in relation to scoring depth

1. Subject

The specifying and measuring of **folding torque in relation to scoring depth** as used in the packaging industry when die cutting and/or scoring.

2. Application area

This specification can be used in the following areas:

- rotary die cutting
- flatbed die cutting
- flexo folding gluing process.

3. Definition

The units used for measuring folding torque in relation to scoring depth are:

- folding torque: Nm (Newton meter)
- folding angle: ° (degree)
- scoring depth: mm (millimetre)

Folding torque is the torque needed to fold a panel of a box or a scored sheet over the score line. The folding torque is measured in relation to the rotation angle of the panel folded.

The maximum folding torque is the maximum value measured for folding torque when folding a panel over an angle of 90° from flat.

Scoring depth is the depth of a score measured on a scored sheet (e.g. on the corrugator or a slotter) or a die cut sheet.

The score depth needs to be measured on both sides of the scored sheet depending on the score profile type e.g.: male/male or male/female. The measuring of the score profile can be done using the same measuring principle as described in TS0602: Die cutting, scoring depth variation. It is also important to measure the displacement along the sheet for the scoring profile.

The folding torque is influenced by:

- board grade
- scoring profile
- scoring depth
- flute direction relative to the score line.

4. Test method

Measuring scoring profile



Samples need to be prepared of equal width (e.g. 90 mm) for the measuring of the folding torque in relation to scoring depth. For each measuring series at least 25 samples should be prepared. Tests can be done using the same board grade and different scoring depths.

From one sample the score profile is measured on both sides of the sample sheet. Scanning the depth of the score line can be done using a non-contact laser depth sensor with a resolution of 4 µm as shown (Baumer distance sensor: OADM 12I6430/S35A) in combination with a 16 bit AD convertor.

The movement across the score line also needs to be measured. This can be done using a micrometer with a range of, for example, 27mm.

The depth and displacement over the sheet data is collected in a spreadsheet or database. This allows for an X/Z diagram representing the score line profile, for both sides of the board.

A crush value can be calculated as the percentage of the maximum score depth (sum of score depth on both sides) relative to the board thickness.

$$\text{crush\%} = \frac{\text{score depth}}{\text{board thickness}} * 100\%$$

Measuring folding torque

Folding torque over rotation angle is measured using a force sensor with an accuracy of 0.001 N, e.g. HBM 20N force load cell. The rotation angle is recorded using an encoder having, for example, a resolution of 0.003 rad. The data recording speed of the sensors used needs to be sufficiently high, such as 65 readings per second when the rotation speed of the test is 1.8 RPM (revolutions per minute). The distance between the positioning of the load cell and the score line needs to be accurately measured and the same for all tests.

When measuring folding torque over rotation angle the data is collected in a spreadsheet or database.

The folding torque can be standardised over the width of the sample resulting in the standardised folding torque having the unit N (Newton).

A relative folding torque can be represented by measuring the maximum folding torque of unscored board and expressing the folding torque of scored board as a percentage of the folding torque of unscored board.

$$\text{torque\%} = \frac{\text{max. torque scored sheet}}{\text{max. torque unscored sheet}} * 100\%$$

5. Results reporting

The following graph shows the scan of a score profile:

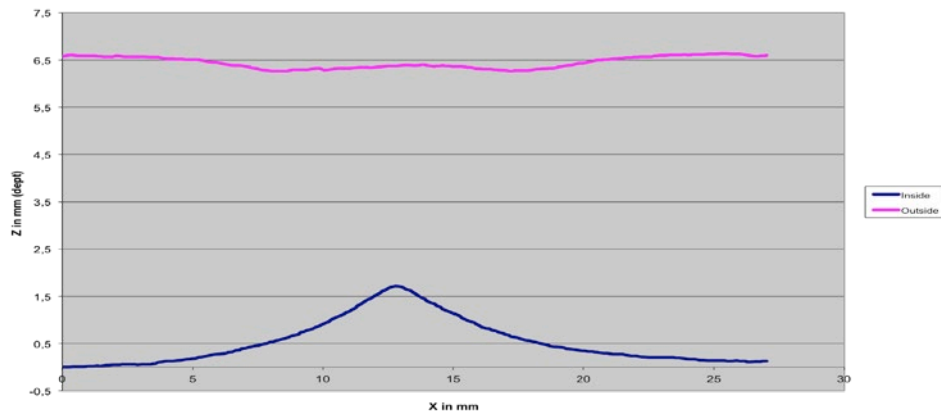

The maximum score depth and crush value are recorded.

The folding torque in relation to rotation angle is shown in the following graph for 25 samples:

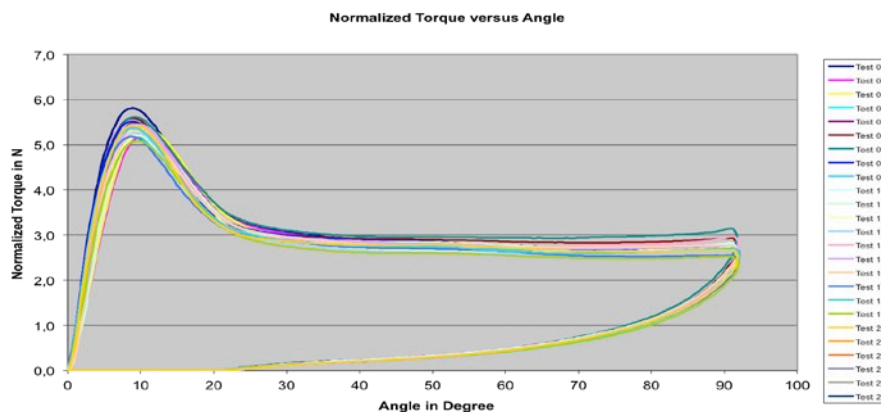

The maximum value for folding torque and corresponding angle is recorded.

The following example shows the 25 maximum folding torques and corresponding folding angle of the test above:

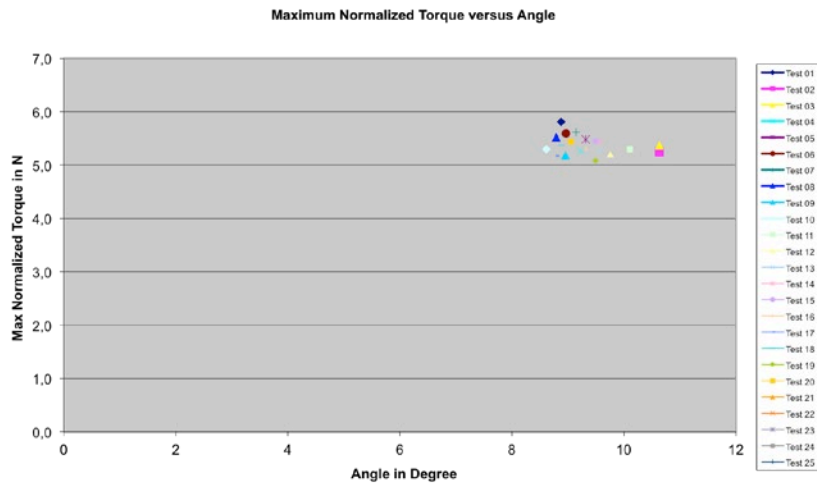

Combining the results of relative folding torque for the same board grade (e.g. B-flute) and crush percentage can be presented in a graph for relative maximum folding torque in relation to crush percentage as shown:

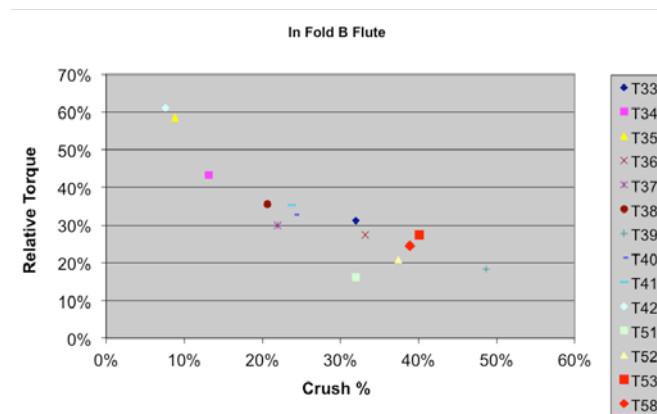

6. Target

Target levels are always agreed between customer and supplier.

The target level for folding torque depends on board grade and what is needed to erect the box without stopping packing line production.

References

TS0602: Die cutting, scoring depth variation

Folding

Number of stitches

1. Subject

The specifying and measuring of the **number of stitches** per product on a stitcher as used in the corrugated packaging industry to manufacture a regular slotted case (RSC).

2. Application area

This specification can be used in the following area:

- flexo folding gluing process

3. Definition

The unit used for measuring number of stitches is stitch count/metre.

The number of stitches is the count of stitches per box used on the manufacturer's joint of a RSC.

The number of stitches is standardized for the length of the lash (manufacturer's joint). The number of stitches in #/sheet divided by the length of the lash results in stitches per metre: #/m.

4. Test method

The number of stitches is measured by counting the number of stitches on the lash of 25 consecutively produced sheets and measuring the lash length.

The number of stitches per sheet for 25 sheets is recorded in a spreadsheet or database.

The number of stitches in #/sheet is divided by the lash length resulting in the number of stitches per metre: #/m.

The average number of stitches in #/m is calculated from 25 data points.

The maximum and minimum deviation for number of stitches per metre is determined from the 25 data points against the average number of stitches per metre.

5. Results reporting

Reported, using the collected data, is the average number of stitches per metre (#/m), the maximum and minimum values.

6. Target

Target levels are always agreed between customer and supplier.

Stitches #/m: $x \pm 1/m$

The target speeds for running the tests are 50%, 70% and 90% of the maximum machine speed.

Stitches #/m should be constant independent of machine speed.

Folding

Tape consumption

1. Subject

The specifying and measuring of tape consumption per box on a flexo folder gluer (FFG) or taper as used in the corrugated packaging industry to manufacture a regular slotted case (RSC).

2. Application area

This specification can be used in the following area:

- flexo folding gluing process

3. Definition

The unit used for measuring average tape consumption is m tape/m lash (ratio).

Tape consumption is the amount of tape in metres used on the lash (manufacturer's joint) per product (RSC).

Tape consumption is standardized for the length of the glue lash. The tape consumption in metres divided by the length of the lash results in a ratio value.

Tape consumption is dependent on the tape type and equipment used and is an average value.

4. Test method

Tape consumption is calculated by measuring the tape reel weight before and after the test. The test should produce at least 25 boxes.

Note that the tape used for setting up the system also needs to be taken into account for an accurate reading.

The tape reel weight is measured using a scale with an accuracy of 0.01 g.

The weight of 1 m tape is measured using a scale with an accuracy of 0.01 g.

The glue lash length is measured.

All values are recorded in a spreadsheet or database.

The amount of tape used is calculated as follows:

$$\text{tape consumption in m/box} = \frac{\text{tape reel weight start} - \text{tape reel weight end}}{\text{weight 1 m tape} * \text{number of boxes}}$$

By dividing tape consumption/box by the lash length results in a tape consumption ratio.

1 indicates that the tape length is equal to the lash length. A value higher than 1 indicates that more tape was used than the lash length.

5. Results reporting

From the test data the number of boxes produced and average tape consumption are reported.

6. Target

Target levels are always agreed between customer and supplier.

The target speeds for running the tests are 50%, 70% and 90% of the maximum machine speed.

The tape consumption target is: 1 ± 0.05

Tape consumption should be constant regardless of machine speed.

Folding

Waste inside folding section

1. Subject

The specifying and measuring of waste inside the folding section of a flexo folder gluer as used in the corrugated packaging industry.

2. Application area

This specification can be used in the following area:

- folding as part of the flexo folding gluing process.

3. Definition

The unit used for measuring waste inside the folding section is $g/(m^3 \cdot 1,000 \text{ sheet})$. Written out in full it is: gramme per cubic metre per one thousand sheets.

The waste inside the folding section measuring area in m^2 is defined as an area in the centre line of the machine with a cross production direction width of 2 metres and a length of 6 metres starting at the sheet entry point of the folding arms.

The number of sheets used for the test is defined in sheets.

The length of the slot depth is defined in mm.

The waste is collected in the designated measuring area after passing the agreed number of sheets for the test and the waste weight is measured using a scale with an accuracy of ± 5 g.

The waste inside the folding section value is the weight of the waste collected inside the designated area in g divided by slot depth in mm, divided by the size of the area in m^2 divided by the number of sheets.

The aim is no waste inside the folding section.

The removal of waste depends on:

- the design of the product made
- the board grade used for the test
- the tooling of the slotting section
- the production machine.

It is important to use a standard product design for measuring waste removal.

4. Test method

The test is done by producing a box with an 8 mm slot and a slotting depth of at least 100 mm.

In addition a die cutting tool can be used in the die cut section if available.

Test procedure:

1. The marked area in the folding section, the folding section and slotting section should be cleaned so that no waste from previous production runs can influence the test result.
2. Mark the waste collection area inside the folding section.
3. Set an agreed number of boxes for the test: $>5,000$ boxes.
4. Measure and record the actual slot depth.
5. Record if a die cut tool is included in the test.
6. Count and record the individual boxes produced during the test until the agreed number of boxes is reached.
7. Record the number of boxes actually produced.
8. Collect and weigh the waste in the designated area.
9. Calculate the "waste inside the folding section" value.

Waste inside the folding section equation (normalized value):

$$\text{Waste inside folding section} = \left(\frac{100,000 * \text{Weight of waste inside designated area}}{\text{Slot depth} * \text{Area} * \text{Number of sheets}} \right)$$

Waste inside folding section = g/(m³ * sheet)

Weight of waste inside designated area = weight in g

Slot depth = Depth in mm

Area = Size of designated area in m² ==> length * width

Number of sheets = the actual count of sheets produced during the test

5. Results reporting

The results can be reported as a factor for the test variables as shown in the following table:

TestID	Board grade	Slot depth	#Sheets	Waste inside the folding section g/(m ³ *1,000sheet)
1	B/C	100 mm	5,000	4
2	B	100 mm	6,500	2

6. Target

Target levels are always agreed between customer and supplier.

The target speed for running the test is 90% of the maximum machine speed.

The following table is an example for target waste inside the folding section values:

	B flute	BC flute
Slotting only	<2 g/(m ³ *1,000sheet)	<4 g/(m ³ *1,000sheet)
Die cutting and slotting	<4 g/(m ³ *1,000sheet)	<8 g/(m ³ *1,000sheet)

Stacking

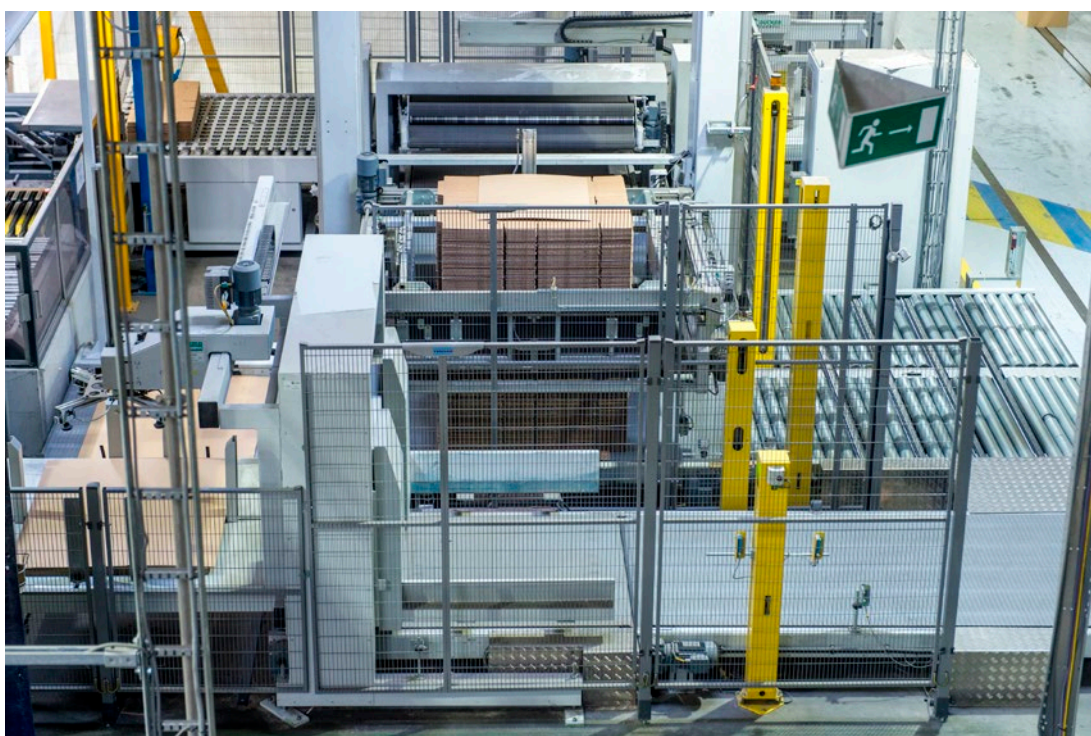

Document#	Name
0801 V1.0	Alignment
0802 V1.0	Stops/1,000 sheets
0803 V1.0	Exact sheet count

Stacking

Alignment

1. Subject

The specifying and measuring of **stack alignment** when stacking sheets at the end of conversion equipment as used in the corrugated packaging industry.

2. Application area

This specification can be used for the stacking of corrugated sheets in the following areas:

- printing offline
- printing die cutting
- offline cutting
- dry end corrugator.

3. Definition

The unit used for measuring alignment is mm (millimetre).

The maximum diagonal stack distance is the distance measured from one corner of the stack to the diagonal opposite corner.

The alignment error D_s is the maximum diagonal stack distance minus the diagonal sheet distance of the stacked sheets.

The following diagrams show how the stack alignment changes the maximum diagonal stack distance due to sheet offset or sheet rotation during stacking.

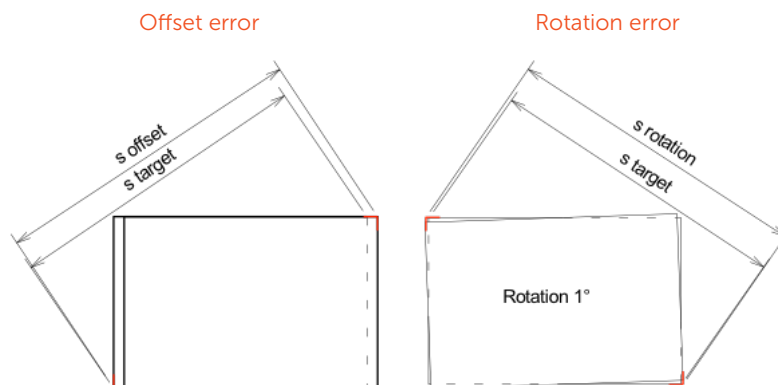

Stack alignment is influenced by:

- sheet warp
- sheet transport system
- sheet stacking (the stacker).

4. Test method

Sheet stacking alignment should be measured on at least 10 consecutively produced pallets with a stacking height of > 1m.

The following drawing shows how perpendicular to the ground positioned L profiles (red) are positioned on two diagonal opposite corners between which the distance s is measured.

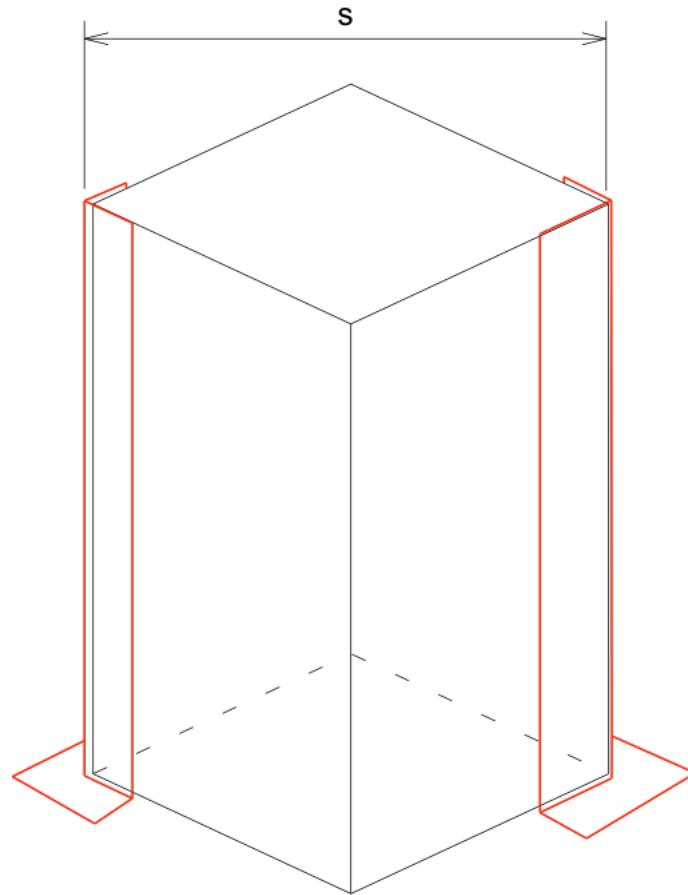

The measured value for s is recorded in a spreadsheet for 10 consecutively produced pallets including the pallet height.

The alignment error Δs is calculated by subtracting the s value by the diagonal distance of the sheet which can be calculated using the formula:

$$s = \sqrt{h^2 + w^2}$$

h is the height of the sheet and w is the width of the sheet.

5. Results reporting

The following chart is an example of Δs values measured for 10 consecutively produced pallets:

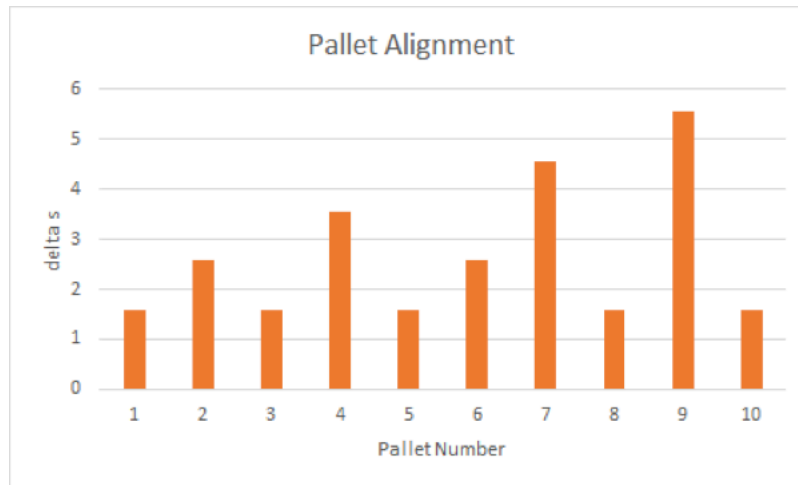

The maximum $\Delta s < 6$ mm.

6. Target

Target levels are always agreed between customer and supplier.

The target conversion equipment speed for running the test is 90% of the maximum machine speed.

The stacking alignment error target is: max $\Delta s < 5$ mm (pallet height > 1 m)

Stacking

Stops/1,000 sheets

1. Subject

The specifying and measuring of **stops/1,000 sheets** when stacking sheets at the end of conversion equipment as used in the corrugated packaging industry.

2. Application area

This specification can be used for the stacking of corrugated sheets in the following areas:

- printing offline
- printing and rotary die cutting
- printing and flatbed die cutting
- offline flatbed die cutting.

3. Definition

The units used for measuring stops/1,000 sheets are:

- number of stops/1,000 sheets
- time in seconds per stop
- percentage stop time of the total available production time.

Stops are defined as disruptions in production caused by stacking resulting in a deviation from the set running speed of the machine.

4. Test method

The pre-feeder and feeder need to be monitored to avoid production interruption when testing the stacker. Stops caused by feeder and/or pre-feeder are recorded and disregarded during the evaluation of the stacker performance.

The bundles/stacks delivered by the stacker are immediately removed so as not to disrupt the process.

The sheets running through the machine are detected using a sensor. Every sheet is counted and when detected the time from the start is recorded.

The following is calculated from the collected data:

- time between detecting sheets
- the speed of the machine at the time of the sheet passing through.

The test can be conducted during the standard production of a large order, preferably >5,000 sheets.

The number of stops is counted during the conversion of the board. For each stop the reasoning should be logged. For example, the evacuation of an empty pallet or removal of damaged sheets.

It is important that the stacker does not cause production stops.

The following is calculated from the collected data:

- percentage downtime
- stops/1,000 sheets.

The equation for calculating percentage downtime is:

$$\% \text{ downtime} = \frac{\text{stop time}}{\text{time producing} + \text{stop time}} * 100\%$$

The equation for calculating stops/1000 sheets is:

$$\text{stops/1000sht} = \frac{\text{number of stops} * 1000}{\text{number of sheets}}$$

Tests should be conducted using:

- different board grades
- different sheet sizes
- machine speed >90% of maximum speed.

Test results are influenced by:

- board grade (flute type: B, C, BC, E, BE etc.)
- board size
- stacker performance
- production speed.

5. Results reporting

The following graphs show the results of a simulated run of 1,000 sheets using a sensor detecting every sheet passing through the machine.

Tests should be preferably done with 5,000 sheets.

For the example the total production time used to produce 1,000 sheets was: 958.8 seconds.

The collected data is shown in graphs.

Sheet detection versus time graph:

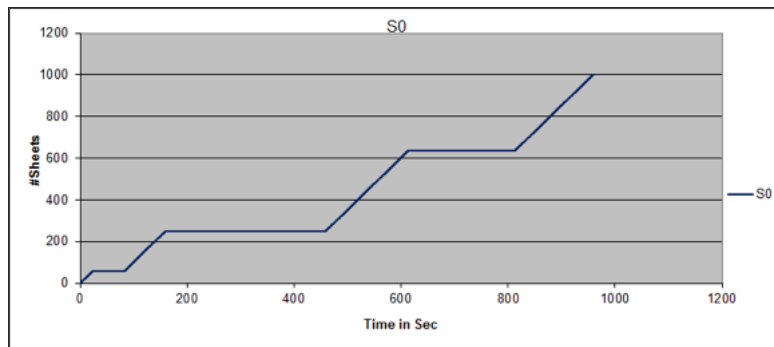

The three horizontal periods over time indicate the time when no sheets were detected.

Sheet speed graph:

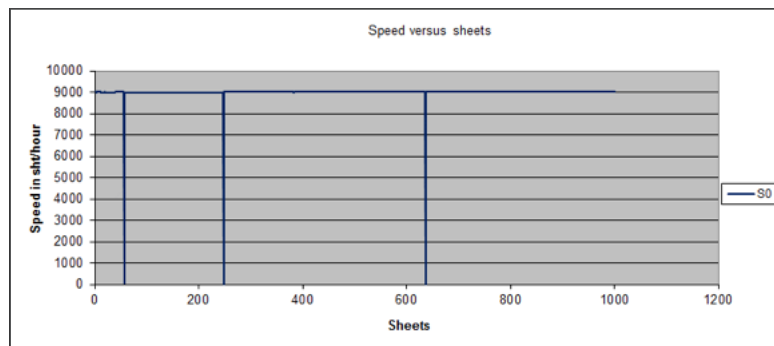

There were three interruptions in the speed graph.

Sheet interval time graph:

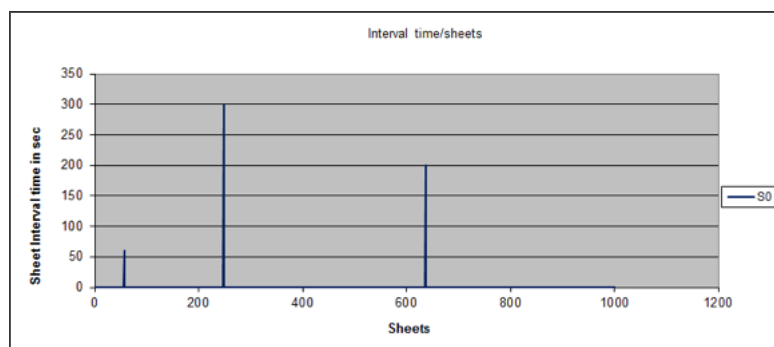

The graph shows three relatively large intervals between sheets:

1. 60 seconds
2. 300 seconds
3. 200 seconds

Using the equation for percentage downtime:

Percentage downtime for the example is: $100 * 560/958.8 = 58\%$

Using the equation for stops/1000 sheets: $3*1000/1000 = 3$

Stops/1000 sheets for the example is: 3

6. Target

Target levels are always agreed between customer and supplier.

The target conversion equipment speed for running the test is 90% of the maximum machine speed.

The target for the stacking is:

- < 1 stop/1,000 sheets
- downtime < 3%

Stacking

Exact sheet count

1. Subject

The specifying and measuring of **exact sheet count** when stacking sheets or bundling folded boxes at the end of conversion equipment as used in the corrugated packaging industry.

2. Application area

This specification can be used for the stacking and/or bundling of corrugated sheets in the following areas:

- printing offline
- printing and rotary die cutting
- printing and flatbed die cutting
- offline flatbed die cutting
- printing, slotting, scoring and folding as part of the flexo folding gluing process.

3. Definition

The units used for measuring exact sheet count are:

- number of sheets/pallet
- number of sheets/bundle.

Exact sheet count is defined as the difference between the number of sheets on a pallet or in a bundle and the pre-set value. The target is 0 sheets.

4. Test method

The test methods described measure the difference between the target number of sheets on a pallet or in a bundle and the actual number of sheets on the pallet or in the bundle.

>5 pallets or >50 bundles are part of an evaluation.

There are four measuring methods that can be used to determine the number of sheets on a pallet or in a bundle:

1. Manually counting the sheets.
2. Calculation based on the thickness of a sheet and the height of the stack.
3. Calculation based on the weight of a sheet and the weight of a pallet or bundle.
4. Timing the evacuation of bundles or pallets in relation to sheets produced. (machine speed).

The following matrix shows the relation between the accuracy of the measuring method and the area of application:

Accuracy	Pallet	Bundle
High	<ul style="list-style-type: none"> • Manual count 	<ul style="list-style-type: none"> • Manual count • Weight • Height/thickness
Medium	<ul style="list-style-type: none"> • Height/thickness 	<ul style="list-style-type: none"> • Timing
Low	<ul style="list-style-type: none"> • Weight • Timing 	

Manual count

The individual sheets on a pallet or in a bundle are manually counted.

Height/ thickness

The thickness of a single sheet or a stack of 10 sheets is measured using a Vernier or micrometre. The height of the stack is then measured using a tape measure and is divided by the thickness of a single sheet.

The error for this measuring method depends on the total height of the stack and the accuracy of the thickness and height measurement tool.

Weight

The weight of a single sheet or a stack of 10 sheets is measured using a scale with an accuracy of < 5 g. The weight of the stack is then measured using a scale with an accuracy of < 10 g divided by the weight of a single sheet.

The error for this measuring method depends on the total weight of the stack and the accuracy of the weight measurement tool (scale).

Timing

The individual sheets are detected and the pallets or bundles evacuated are detected. The time between sheets needs to be constant as does the time between evacuating bundles. If this is so, dividing the time/bundle (or pallet) by the time per sheet results in the number of sheets per bundle or pallet.

The accuracy of this measuring method will give an average result for the number of sheets per bundle or pallet but the accuracy of the actual number of sheets per individual pallet or bundle is low.

5. Results reporting

The following chart shows the sheet count deviation evaluation of five pallets where the target is 1,000 sheets/pallet:

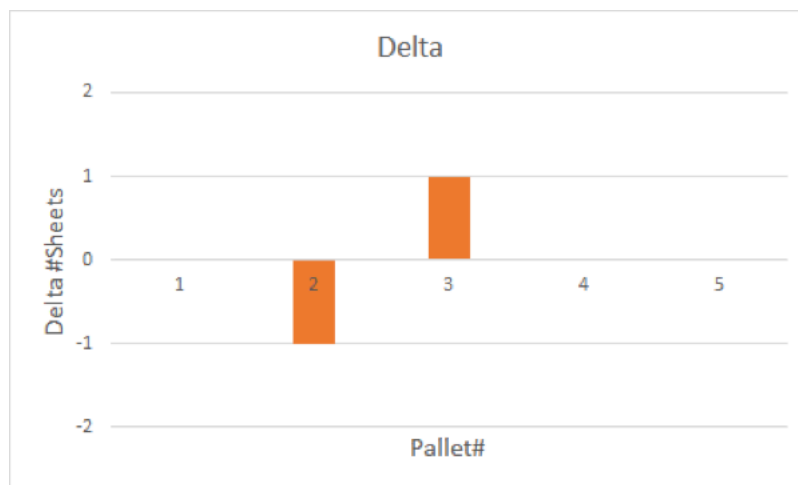

Pallet two was one sheet short, pallet three had one sheet too many.

6. Target

Target levels are always agreed between customer and supplier.

The target conversion equipment speed for running the test is 90% of the maximum machine speed.

The targets for exact sheet count are:

- ± 1 sheet/pallet
- average sheet/pallet \geq target sheet/pallet

Bundling



Document#	Name
0901 V1.0	Stops/100 bundles

Bundling

Stops/100 bundles

1. Subject

The specifying and measuring of **stops/100 bundles** when stacking sheets at the end of a flexo folder gluer as used in the corrugated packaging industry.

2. Application area

This specification can be used in the following areas:

- flexo folding gluing process (counter ejector)
- strapping.

3. Definition

The units used for measuring stops/100 bundles are:

- number of stops/100 bundles
- time in seconds per stop
- percentage stop time of the total available production time.

Stops are defined as disruptions in production caused by bundling resulting in a deviation from the set machine production speed.

4. Test method

The total conversion process needs monitoring to avoid production interruption when testing the bundler or strapper. Stops caused by pre-feeder, feeder and/or folding section are recorded and disregarded during the evaluation of the bundling or strapping performance.

The bundles delivered from the bundler or strapper should be immediately removed so as not to disrupt the process.

The bundles ejected by the machine are detected using a sensor. Every bundle is counted and when detected the time from start-up is recorded.

The following is calculated from the collected data:

- time between detecting bundles
- the bundling speed of the machine at the time of the bundle being ejected or strapped.

The test can be conducted during the standard production of a large order, preferably >250 Bundles (e.g. one bundle of 20 sheets → 5,000 sheets).

The number of stops are counted during the conversion and bundling of the board. For each stop the reasoning is logged such as the evacuation of an empty pallet or the removal of damaged sheets.

It is important that bundling does not cause production stops.

The following is calculated from the collected data:

- percentage downtime
- stops/100 bundles.

The equation for calculating percentage downtime is:

$$\% \text{ downtime} = \frac{\text{stop time}}{\text{time producing} + \text{stop time}} * 100\%$$

The equation for calculating stops/100 bundles is:

$$\text{stops/100bundles} = \frac{\text{number of stops} * 100}{\text{number of bundles}}$$

Tests should be conducted using:

- a different number of sheets per bundle
- different board grades
- different sheet sizes
- a machine speed of >90% of maximum speed.

Test results are influenced by:

- board grade (flute type: b, c, bc, e, be etc)
- board size
- number of sheets per bundle
- bundler/strapper/counter ejector performance
- production speed.

5. Results reporting

The following graphs show the results of a simulated run of 40 bundles using a sensor detecting every bundle ejected by the machine.

Tests should preferably be done with 250 bundles.

For the example the total production time used producing 40 bundles is 958.8 seconds.

In the example the machine speed was 9,000 sheets/hour resulting in a production time per sheet of 0.4 seconds. There are 25 sheets per bundle. One bundle is evacuated by the machine every 10 seconds.

The collected data is represented in graphs.

Bundle detection versus time graph:

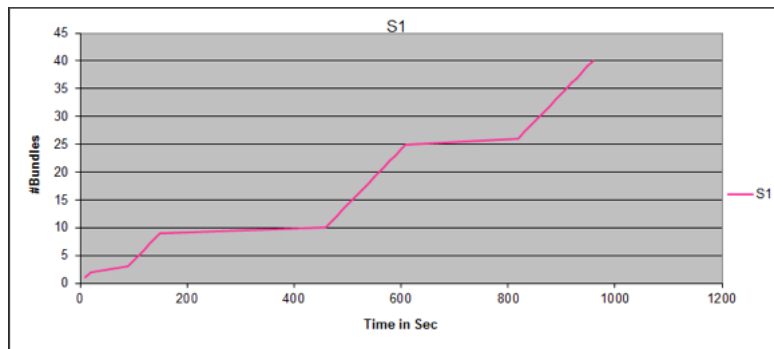

The three horizontal periods over time indicate the time when no bundles were detected.

Bundle speed graph:

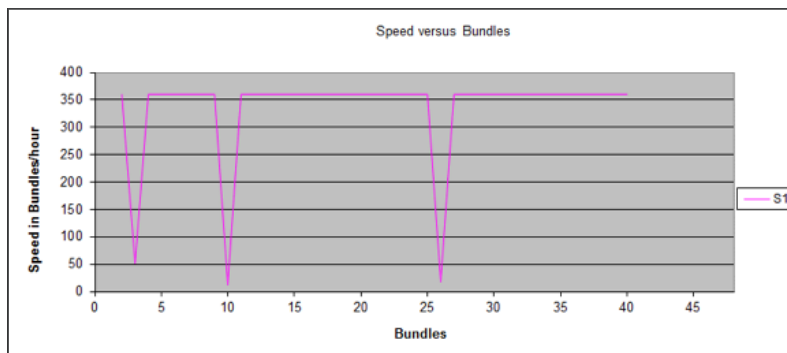

There are three interruptions in the speed graph. Nominal speed is 360 bundles/hour.

Bundle interval time graph:

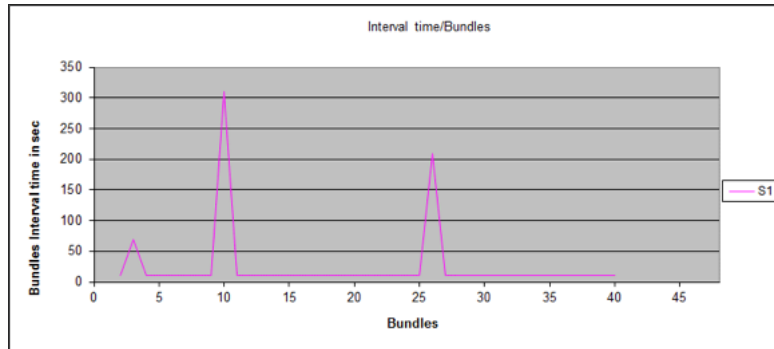

The graph shows three relatively large intervals between bundles:

1. 69.6 seconds. 9.6 seconds was used for standard production → Stop time is 60 seconds.
2. 309.6 seconds. 9.6 seconds is used for standard production → Stop time is 300 seconds.
3. 209.6 seconds. 9.6 seconds is used for standard production → Stop time is 200 seconds.

Using the equation for percentage downtime:

Percentage downtime for the example is $100 * 560/958.8 = 58\%$

Using the equation for stops/100 bundles:

$$3 * 100/40 = 7.5$$

Stops/100 bundles for the example is 7.5.

6. Target

Target levels are always agreed between customer and supplier.

The target conversion equipment speed for running the test is 90% of the maximum machine speed.

The targets for stacking are:

- < 1 stop/100 bundles
- downtime < 3%

Breaking



Document#	Name
1001 V1.0	Breaking force in relation to bundle height
1002 V1.0	Breaking cycle time

Breaking

Breaking force in relation to bundle height

1. Subject

The specifying and measuring of **breaking force in relation to bundle height** as used in the conversion and packaging industry.

2. Application area

This specification can be used in the following area:

- board conversion after die cutting rotary or flatbed.

3. Definition

The unit used for measuring breaking force in relation to bundle height is number of sheets.

The breaking force in relation to bundle height is the maximum number of non-deformed sheets for a given board grade that can be used for performing a good breaking cycle.

The breaking force in relation to bundle height is influenced by the:

- design of the sheet to break
- position of nick points
- board grade
- stack height.

4. Test method

Before conducting the breaker tests sheets need to be die cut and stacked. The maximum stack height by board grade needs to be defined by the machine supplier.

Tests should be done for individual board grades using the same die cut design.

The design of the sheets that are used for the breaking test can differ depending on the size of the die cutter in front of the breaker.

The following diagram shows a cutting die of four up by five across which is a typical width for a 66 inch rotary die cutter.

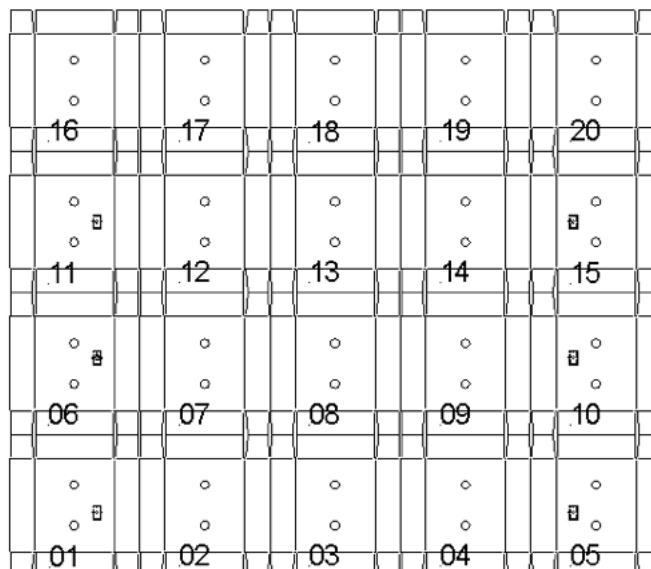

For the breaking test it is important that sheets are correctly cut and the nick positions are pre-defined. Score depth is of secondary importance.

Stacks are prepared according to the agreed height defined in the test. At least five stacks are broken using at least one sheet more than is indicated by the machine supplier for the board grade. The test is repeated after increasing the stack by one sheet until the breaker is not able to break the stack.

A video camera is used to video the breaking cycle. The time needed for the breaking cycle is measured by evaluating the video footage.

The following is recorded from the tests:

- stack height
- board grade
- breaking design (number up and number across)
- breaking cycle time.

5. Results reporting

The following graph shows the cycle time by board grade for the number of sheets used as an example of breaking force in relation to stack height.

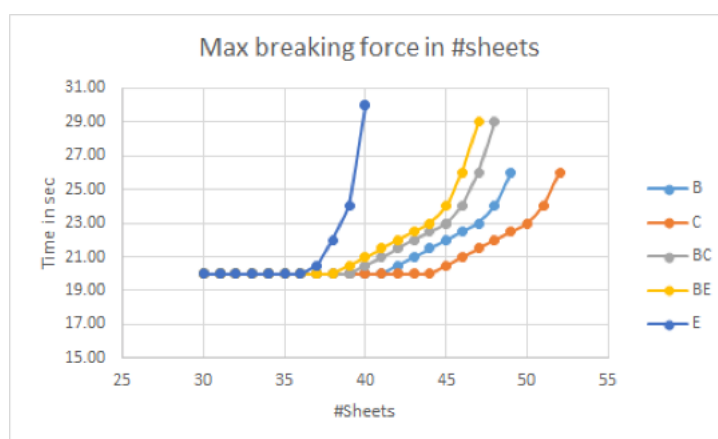

The following table shows the key values derived from the sample tests.

Board grade	Max. # sheets supplier	Max. # sheets test	Breaking cycle time in seconds
B	40	49	26
C	40	52	26
BC	20	22	29
BE	20	23	29
E	60	62	30

6. Target

Target levels are always agreed between customer and supplier. The target values for maximum number of sheets by board grade are defined by the machine supplier. The paper used by board grade has to be agreed between supplier and customer.

Board grade	Max # sheets supplier	Breaking cycle time
B	40	< 15 sec
C	40	< 15 sec
A	20	< 15 sec
E	60	< 15 sec
BC	20	< 15 sec
BE	40	< 15 sec

Breaking

Breaking cycle time

1. Subject

The specifying and measuring of **breaking cycle time** as used in the conversion and packaging industry.

2. Application area

This specification can be used in the following area:

- board conversion after die cutting rotary or flatbed

3. Definition

The unit used for measuring breaking cycle time is seconds.

The breaking cycle time is the total time in seconds needed to perform one breaking cycle of a complete stack of die cut sheets.

The full cycle consists of:

- the time for the bundle of sheets to enter and leave the breaker
- the time for the actual breaking of the bundle.

The required breaking cycle time for the production process is dependent on:

- machine production speed
- number of break cycles per product
- number of sheets per stack supplied for breaking.

The breaking cycle time is influenced by the:

- design of the sheet to break
- position of nick points
- board grade
- stack height.

4. Test method

Before conducting the breaker tests sheets need to be die cut and stacked. The stack height needs to be defined. The maximum breaking time calculated in relation to machine speed and stack height also needs to be defined.

The maximum breaking cycle time for breaking one stack of sheets can be calculated using the following equation:

$$\text{breaking cycle time} = \frac{\text{number of sheets per stack}}{\text{machine speed}} * 3,600$$

Units are expressed as follows:

- breaking cycle time in seconds
- number of sheets per stack in sheet count
- machine speed in sheets/hour.

The design of the sheets that will be used for the breaking test can differ depending on the size of the die cutter in front of the breaker. The following diagram shows a cutting die of four up by five across which is the typical width for a 66 inch rotary die cutter.

○	○	○	○	○	
○	○	○	○	○	
16	17	18	19	20	
○	○	○	○	○	
○	○	○	○	○	
11	12	13	14	15	
○	○	○	○	○	
○	○	○	○	○	
06	07	08	09	10	
○	○	○	○	○	
○	○	○	○	○	
01	02	03	04	05	

For the breaking test it is important that sheets are correctly cut and the nick positions are pre-defined. Score depth is of secondary importance.

Stacks are prepared according to the agreed height defined in the test. At least five stacks should be broken. The worst case scenario in terms of board grade and design should be used for the test.

A video camera is used to video the cycle.

The time needed for the breaking cycle is measured by evaluating the video footage.

The following is recorded from the tests:

- stack height
- board grade
- breaking design (number up and number across)
- the time taken for the bundle of sheets to enter and leave the breaker
- the time taken for the actual breaking of the bundle.

5. Results reporting

The available cycle time can be calculated based on machine speed and stack height. The following graph shows the relation between cycle time and stack height. Data lines are shown for 100%, 80% and 50% machine speed. The maximum machine speed in this example is 10,000 sheets/hour.

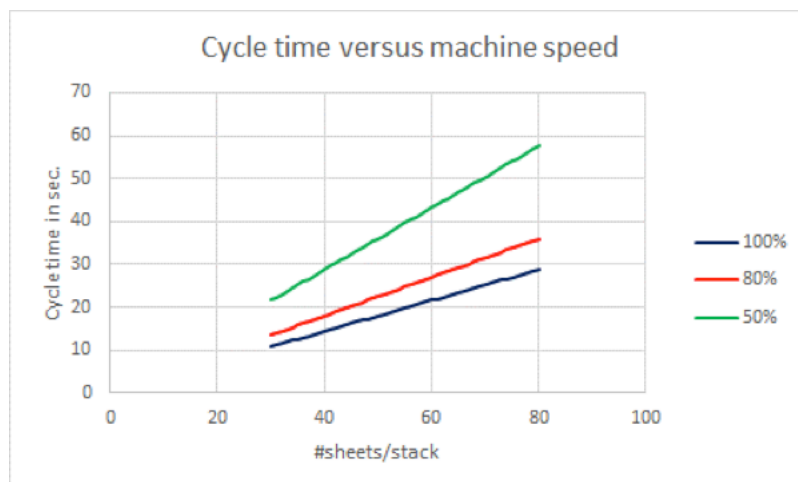

The following graph shows an example for the breaker between the total cycle time and the number of breaks based on a breaking time of 2.5 seconds and a time of 4.5 seconds needed for the stack to enter and leave the breaker.

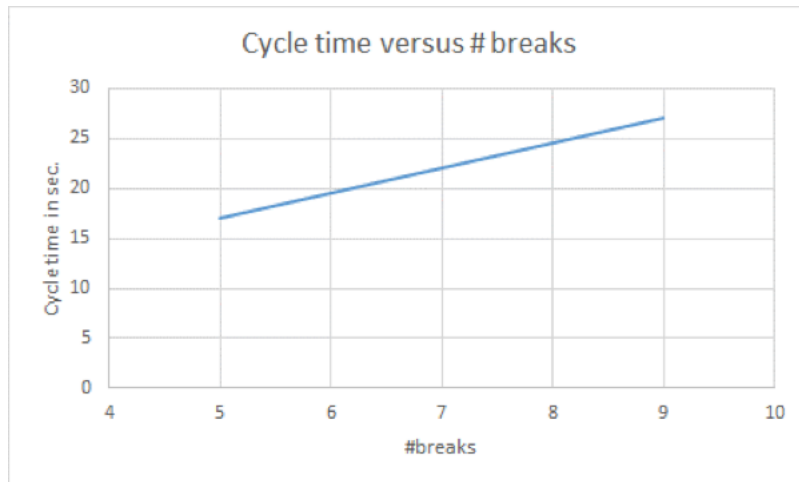

By combining the cycle time machine speed graph and the cycle time versus #breaks graph results in the time needed for nine breaks, which is 27 seconds. Thus the maximum stack height is 59 sheets so that this breaking cycle time does not interrupt the production of die cut sheets when running at 80% of the machine speed.

6. Target

Target levels are always agreed between customer and supplier.

The target by board grade in relation to stack height is:

$$\text{breaking cycle time} < \frac{\text{number of sheets per stack}}{\text{machine speed}} * 3,600$$

$$\text{breaking cycle time} < (\text{number of sheets per stack}) / (\text{machine speed}) * 3,600$$

Palletising

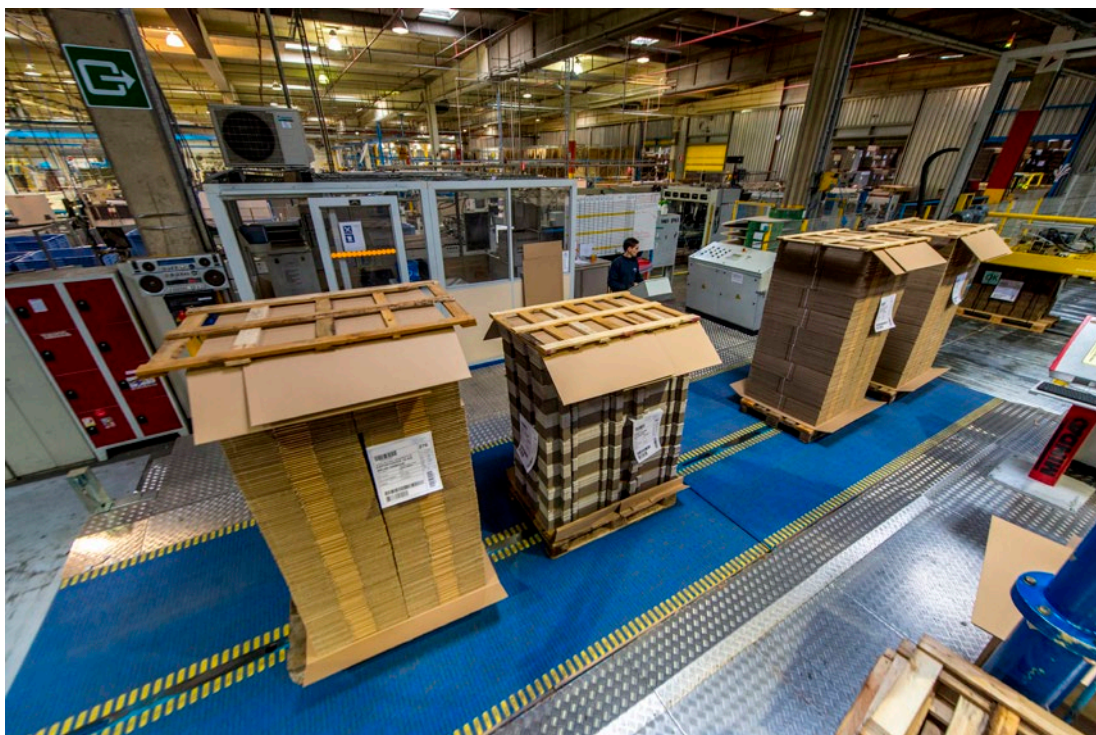

Document#	Name
1101 V1.0	Stops/pallet
1102 V1.0	Production speed in function of stacking pattern
1103 V1.0	Internal transport stacked product stability

Palletising

Stops/pallet

1. Subject

The specifying and measuring of **stops/pallet** when palletising sheets or bundles received from conversion equipment as used in the corrugated packaging industry.

2. Application area

This specification can be used when palletising sheets or bundles in the following areas:

- printing offline
- printing and rotary die cutting
- printing and flatbed die cutting
- offline flatbed die cutting
- printing, slotting scoring and folding as part of the flexo folding gluing process.

3. Definition

The units used for measuring stops/pallet are:

- number of stops/pallet
- time in seconds per stop
- percentage stop time of the total available production time.

Stops are defined as disruptions in production caused by palletising sheets or bundles received from conversion equipment resulting in a deviation from the set running speed of the machine.

4. Test method

The palletiser should be running in auto mode.

The sheets running through the machine are detected using a sensor. Every sheet is counted and when detected the time from the start is recorded.

The following is calculated from the collected data:

- the time between detecting sheets
- the speed of the machine at the time of the sheet passing through.

The test can be conducted during the standard production of a large order of preferably >5,000 sheets (if 500 sheets/pallet → > 10 pallets).

The number of stops is counted during the conversion of the board. For each stop the reasoning should be logged. For example, the evacuation of an empty pallet, the removal of damaged sheets or the insertion of a pallet in the palletiser.

It is important that the palletiser does not cause production stops.

The following is calculated from the collected data:

- percentage downtime
- stops/pallet.

The equation for calculating percentage downtime is:

$$\% \text{ downtime} = \frac{\text{stop time}}{\text{time producing} + \text{stop time}} * 100\%$$

The equation for calculating stops/pallet is:

$$\text{stops/pallet} = \frac{\text{number of stops} * \text{sheets per pallet}}{\text{number of sheets}}$$

Tests should be conducted using:

- different board grades
- different sheet sizes and/or bundle sizes.

Test results are influenced by:

- board grade (flute type: B, C, BC, E, BE etc.)
- board size
- palletising pattern
- palletiser performance.

5. Results reporting

The following graphs show the results of a simulated run of 1,000 sheets using a sensor detecting every sheet passing through the machine.

Tests should be preferably done with 5,000 sheets (if 500 sheets/pallet → > 10 pallets).

For the example the total production time used producing 1,000 sheets is: 958.8 seconds.

In this example there are 500 sheets/pallet. Two pallets are produced. The average production time per pallet is 479.4 sec.

The collected data is shown in graphs.

Sheet detection versus time graph:

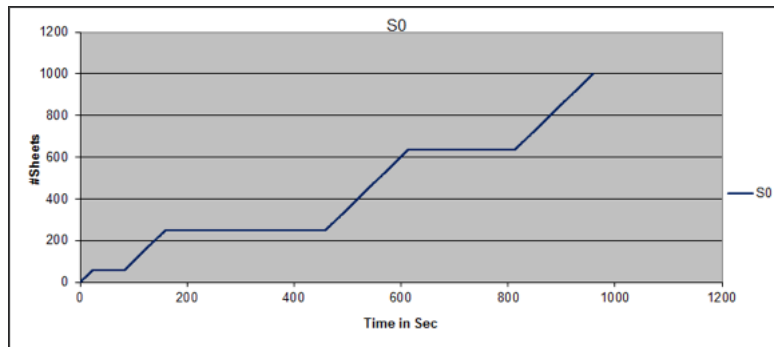

The three horizontal periods over time indicate the time when no sheets were detected.

Sheet speed graph:

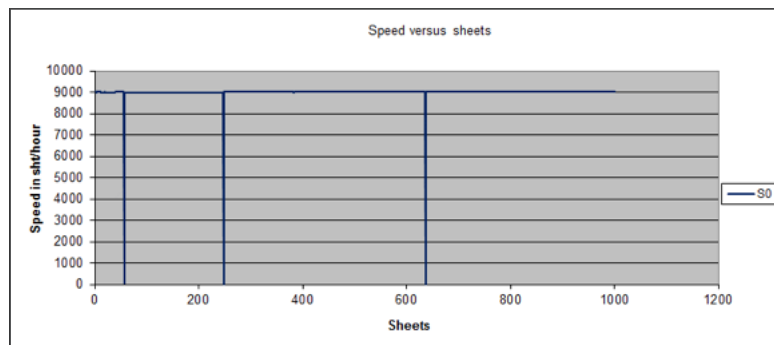

There were three interruptions in the speed graph.

Sheet interval time graph:

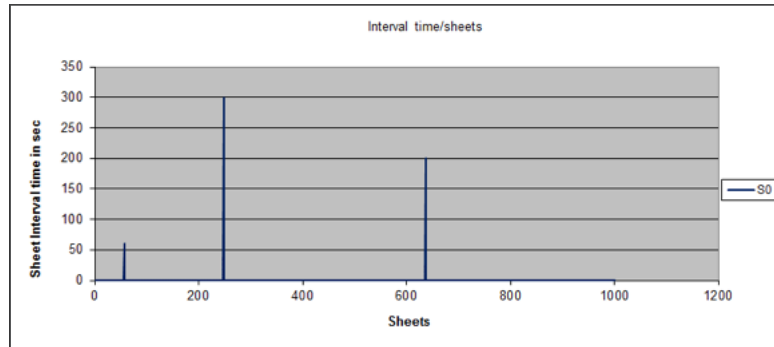

The graph shows three relatively large intervals between sheets for 1,000 sheets linked to the palletiser:

1. 60 seconds
2. 300 seconds
3. 200 seconds

Using the equation for percentage downtime:

The percentage downtime for the example is: $100 * 560/958.8 = 58\%$

Using the equation for stops/pallet:

$$3 * 500/1,000 = 1.5$$

Stops/pallet for the example is: 1.5

6. Target

Target levels are always agreed between customer and supplier.

The palletising pattern used for the test has to be agreed between customer and supplier.

The targets for palletising are:

- < 0.5 stop/1,000 sheets
- downtime < 3%

Palletising

Production speed in function of stacking pattern

1. Subject

The specifying and measuring of **production speed in function of stacking pattern** when palletizing bundles received from conversion equipment as used in the corrugated packaging industry.

2. Application area

This specification can be used when palletizing bundles in the following areas:

- printing and rotary die cutting
- printing and flatbed die cutting
- offline flatbed die cutting
- printing, slotting scoring and folding as part of the flexo folding gluing process.

3. Definition

The units used for measuring stacking speed in function of stacking pattern are:

- maximum production speed in sheets/hour
- number of products/bundle
- number of product bundles per layer
- number of bundles/pallet
- number of products/sheet
- time in seconds per pallet.

The stacking pattern is shown as a design of the layer and stack.

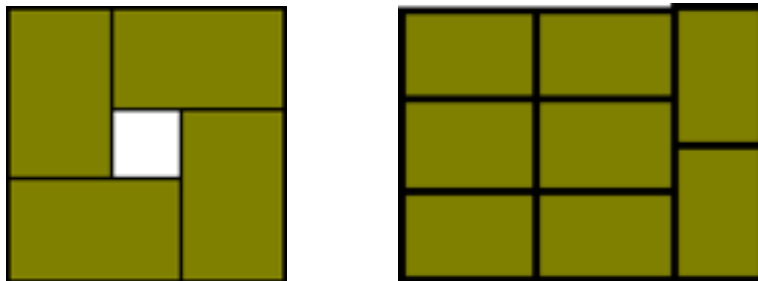

The evaluation is done by measuring the time between starting the first layer of the stack until the start of the first layer of the next stack.

The maximum production speed for the stacking pattern can be calculated using the following formula:

$$\text{Max prod. speed} = \left(\frac{\text{Bundles per stack} * \text{Products per bundle} * 3,600}{\text{Tot. stacking time} * \text{Products per sheet}} \right)$$

Max prod. speed = sheet/hour

Tot. stack time = Time in sec. between starting the first layer of the stack and the first layer of the next stack

Products per sheet = The number of products per sheet converted

Bundles per stack = The number of bundle in one full stack

Products per bundle = The number of products in one bundle

4. Test method

The test is done by measuring the time from laying the first layer of a stack until laying the first layer of the next stack.

Test procedure:

1. Record the design of the stack layer pattern.
2. Calculate the number of bundles per stack based on the stack design.
3. Record the number of products per bundle.
4. Record the number of products per sheet produced.
5. Set the production speed of the production equipment to maximum or produce bundles in advance so that the stacking is not interrupted by bundles not being available.
6. Start the stacking, use a stopwatch to record the time elapsed between laying the first layer of a stack and the first layer of the next stack.
7. Calculate the maximum production speed in function of the stacking time.

Repeat the test for all critical stacking patterns agreed for the equipment.

5. Results reporting

The results can be reported in function of the maximum production speed as shown in the following table:

TestID	Stack pattern design	Prod. /sheet	Prod. / bundle	Bundles / stack	Sec./stack	Max. # shts/ hour
1		6	50	80	260	9,600

The maximum production speed in function of the stacking pattern may be expressed as a percentage of the production speed at which a good product is produced. See standard FC1203 for reference.

6. Target

Target levels are always agreed between customer and supplier.

The target is that the production speed to produce a good product (see standard FC1203) is not limited by more than 10% due to stacking of the products for the individual patterns.

References:

- 1) TS1203, Maximum machine speed to produce a good product.

Palletising

Internal transport stacked product stability

1. Subject

The specifying and determining of the maximum acceleration and deceleration speeds which can be applied to stacked products during internal transport without the stack losing its original shape.

2. Application area

This specification can be used for stacked products in the following areas:

- internal transport system acceleration and deceleration
- stacked product stability.

3. Definition

The units used for measuring the acceleration and deceleration at which stacked products remain stable is m/sec^2 .

The following two acceleration/deceleration values can be measured:

- the maximum acceleration and deceleration of the internal transport system at which it is expected that stacked products will remain stable
- the minimum acceleration and deceleration at which a stack of products must be stable.

Stacks of products will retain their shape during transport if $2 > 1$.

4. Test method

A three axis (X,Y,Z) acceleration sensor is used:

- range: 0-19.61 m/s^2 (0-2 G)
- resolution: 0.01 m/s^2

The sensor is connected to a data logger or PC able to log at least 10 seconds of acceleration data. At least every 2 msec it should measure and record the time and acceleration value of the three individual axes X, Y, and Z.

Testing the transport system:

1. The acceleration setting of the transport system should be 100% of the target acceleration.
2. Place the sensor on an object (e.g. stack) positioned on the transport system.
3. Record the acceleration during a start, the period that the object accelerates from a stationary position until reaching the constant maximum transport speed.
4. Record the deceleration during a stop, the time period that the object decelerates from a constant agreed maximum speed on the transport system back to a stationary position.
5. From the data collected retrieve the maximum deceleration and acceleration values during the start and stop process.

Testing the stack stability:

1. The acceleration setting of the transport system should be 100% of the target acceleration.
2. Place the sensor on an agreed stack of products which are liable to lose their original shape during a too high acceleration and deceleration period.
3. Record the acceleration during a start, the period that the stack accelerates from a stationary position until reaching the constant maximum transport speed.
4. Record the deceleration during a stop, the time period that the stack decelerates from a constant agreed maximum speed on the transport system back to a stationary position.
5. Check if the stack has full kept its original shape, taking if necessary a picture.
6. From the data collected retrieve the maximum deceleration and acceleration values during the start and stop process.

Tests can be repeated changing the acceleration and deceleration settings of the transport system relative to the nominal value or by using different stacked product formations.

The sensor does not need to be perfectly aligned relative to the moving of the object on the transport system. From the maximum acceleration values collected during the tests the total acceleration a_{tot} can be calculated using the following formula:

$$a_{tot} = \sqrt{a_x^2 + a_y^2 + a_z^2}$$

a_{tot} = Total Acceleration in m/sec²
 a_x = Acceleration X in m/sec²
 a_y = Acceleration Y in m/sec²
 a_z = Acceleration Z in m/sec²

It is also possible to use a tilt sensor for data collection. This sensor will provide a value for the acceleration and the spherical direction in space of that acceleration. The acceleration value does not need to be recalculated when using this sensor.

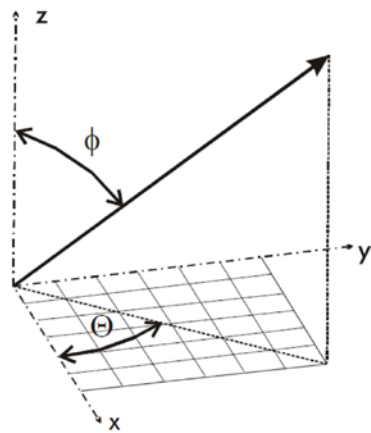

- Absolute length of the acceleration vector
- Zenith Φ : the angle between the positive z-axis and acceleration vector
- Azimuth Θ : the angle between the positive x-axis and the line from the origin to the acceleration vector projected onto the xy-plane.

5. Results reporting

The results of the acceleration tests are reported in a table as follows:

TestID	Start/Stop	a% of nominal	Max a in m/sec ²	Image of stack after the test
0				Image of stack before the test
01a	Start	100%	0.51	
01b	Stop	100%	-0.49	
02a	Start	110%	0.55	
02b	Stop	110%	-0.54	

6. Target

Target levels are always agreed between customer and supplier.

The maximum absolute acceleration value targets are:

- transport system : <0.5 m/sec²
- stack on transport system to retain its shape: > 0.6 m/sec²

General

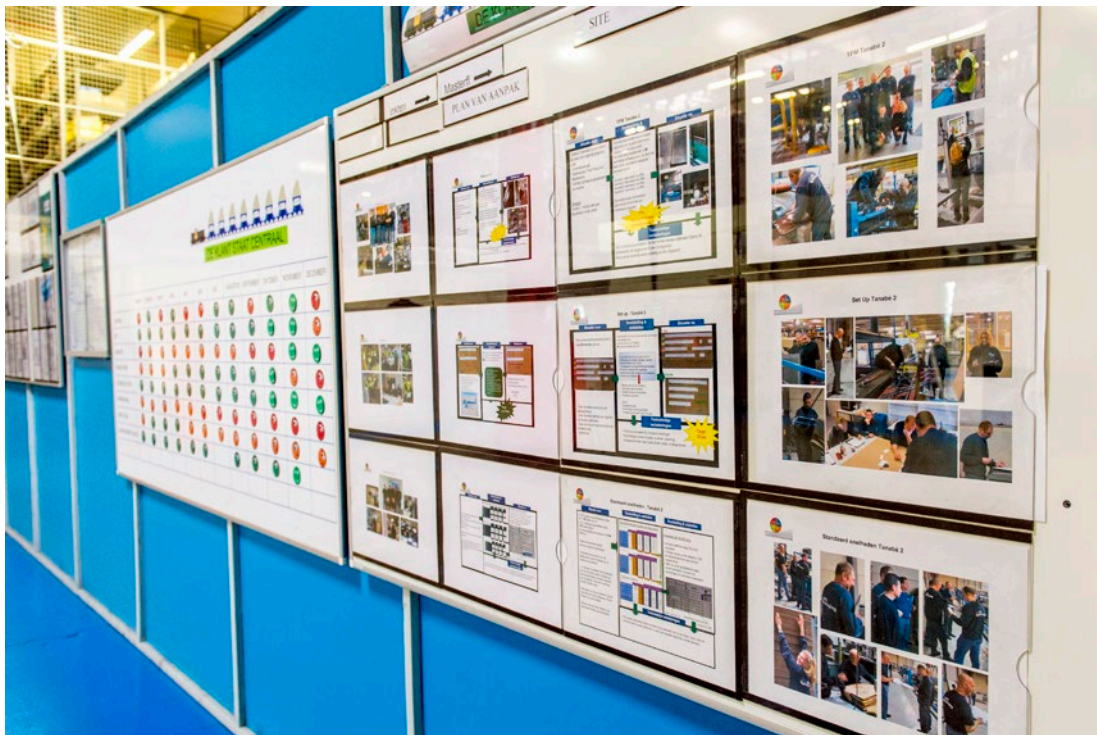

Document#	Name
1201 V1.1	OEE Performance
1202 V1.0	Weighted sound level pressure, ISO 11202 ISO 11204
1203 V1.0	Maximum machine speed to produce a good product

OEE (overall equipment effectiveness) performance

1. Subject

The specifying and measuring of **OEE (overall equipment effectiveness)** performance during conversion equipment production as used in the corrugated packaging industry.

2. Application area

This specification can be used during production for any individual production unit or a series of production units producing inline.

3. Definition

The unit used for measuring OEE is percentage (%).

World class [1] for a production operation can be expressed using the term overall equipment effectiveness (OEE) which identifies how well equipment is running.

Equipment is regarded as world class during standard production if OEE is > 85%.

The OEE consists of three categories:

- availability
- performance
- quality.

The OEE is calculated by multiplying the values of the three categories.

Availability

The availability of equipment is calculated using the following equation:

$$\text{Availability} = \frac{\text{planned production time} - \text{unscheduled downtime}}{\text{planned production time}}$$

Performance

The performance of equipment is calculated using the following equation:

$$\text{Performance} = \frac{\text{cycle time} \times \text{number of products processed}}{\text{production time}}$$

Production time = planned production time – downtime

Quality

The quality of the produced product is calculated using the following equation:

$$\text{Quality} = \frac{\text{number of products processed} - \text{number of products rejected}}{\text{number of products processed}}$$

All three criteria need to be fulfilled in order to be defined as world class.

4. Test method

The machine is monitored over a period of at least three shifts (24 hours) and for at least five different orders.

The following data is collected for the machine and production orders:

- planned production time (based on the information available for the order such as the number of sheets and the agreed machine speed. Machine speed should be at least 90% of the maximum machine speed)
- unscheduled downtime (must be zero for new equipment!)
- cycle time (defined by the machine speed - at least 90% of the maximum speed)
- number of products processed
- production time
- number of products rejected.

The OEE is calculated as follows:

$$\text{OEE} = \text{Availability} \times \text{Performance} \times \text{Quality} \times 100\%$$

5. Results reporting

The OEE value is calculated and presented as a percentage, either by order or for the total evaluation period.

6. Target

Target levels are always agreed between customer and supplier.

The general target for equipment during an acceptance test is:

- OEE > 92%

References

1) Overall equipment effectiveness calculation can be found in any text book about world class manufacturing.

Rev#	Revision	Date
1.1	Added the word "General" to the title	26/4/16

Weighted sound level pressure, ISO 11202 ISO 11204

1. Subject

The measuring of the weighted sound level pressure around production machines as used in the print and packaging industry.

2. Application area

This specification can be used in the following area:

- weighted sound level pressure of production equipment.

This specification can be used during production of any individual production unit or a series of production units producing inline.

3. Definition

The unit used for weighted sound level pressure is dB(A).

The key area where the sound level should be monitored is the operator working area. The sound level needs to stay below the agreed target level and comply with:

- noise directive 2003/10/CE, for the protection of operators
- machine directive 2006/42, for machine suppliers.

4. Test method

A drawing is made of the total machine floor plan. The following is an example:

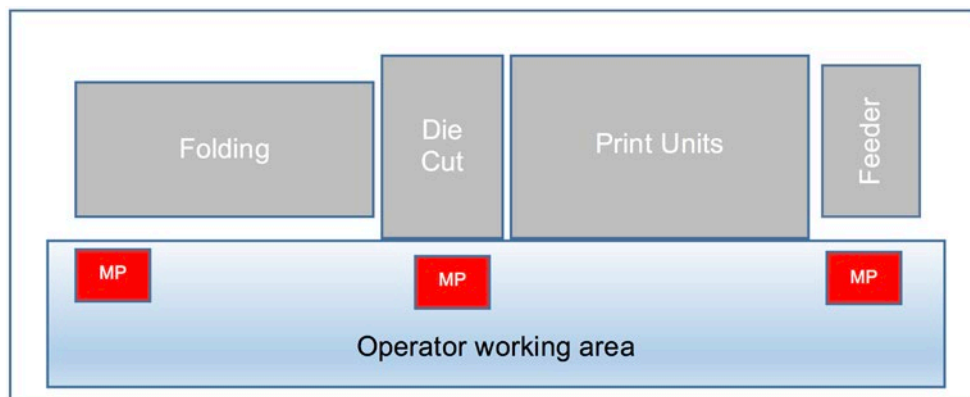

In the floor plan the operator's normal working area is indicated.

On the floor plan the agreed measuring positions (MP) are indicated according to EN13023 (0.5 m from the machine). The measuring positions are the positions where the sound level is likely to be highest when the machine is in production.

The noise level is measured at the normalised hearing height of an operator approximately 1.5 m above the floor level and at a distance of 0.5 m from the machine.

The measuring is done when the machine is running at 90% of the maximum machine speed.

The weighted sound level pressure is measured with calibrated weighted sound level pressure measuring equipment. The measuring is done according to the following standards:

- ISO 11202:2010 when only measuring the weighted sound level pressure produced by the equipment
- ISO 11204:2010 also taking into account the background sound pressure when measuring the weighted sound level pressure produced by the equipment.

In a corrugated board production plant ISO 11204:2010 is recommended.

The weighted sound level pressure is influenced by:

- background noise.

5. Results reporting

The weighted sound level pressure is measured at the indicated positions on the floor plan with and without background noise.

The results are reported in a table showing the number of the measuring position as follows:

Measuring position #	With background noise	Without background noise	Delta noise
1			
2			

6. Target

Target levels are always agreed between customer and supplier.

The target is that the weighted sound level pressure in the indicated places at 90% of the maximum machine speed is < 85 dB(A) when the machine and factory are in production.

Background noise can have a significant impact on the measured weighted sound level pressure. The following criteria apply for the difference between the measured weighted sound level pressure measured on the agreed positions when the machine is running and all other equipment in the plant is running or switched off:

1. If the drop in weighted sound level pressure > 15 dB(A) then the weighted sound level pressure of 85 dB(A) applies.
2. If the drop in weighted sound level pressure < 6 dB(A) then the weighted sound level pressure of 85 dB(A) does not apply.
3. If the drop in weighted sound level pressure is between 6 and 15 dB(A) then a background noise correction will be applied according to chapter 6.4 of the ISO11204 standard.

References:

- 1) Noise level standard ISO 11202:2010
- 2) Noise level standard ISO 11204:2010
- 3) Noise directive 2003/10/CE
- 4) Machine directive 2006/42
- 5) Measuring position directive EN13023

Maximum machine speed to produce a good product

1. Subject

The maximum speed at which a machine can run and still produce a good product which is within customer expectations.

2. Application area

This specification can be used for any individual production unit or a series of production units producing inline.

3. Definition

The units used for maximum machine speed to produce a good product are:

- percentage of maximum machine speed
- sheets/minute
- sheets/hour.

The purpose is to determine the maximum machine speed at which a good product can be produced using the agreed targets for all specifications that apply in function of the materials used e.g. substrate, board grade, ink, overprint varnish, etc.

4. Test method

First of all a list is drawn up of all the quantitative standards required for the product to be approved by the customer and the target pass values are agreed. Standards used may include the "FEFCO technical specifications for converting equipment". Other standards commonly used by the print and packaging industry may also be applied. Only standards which have a direct link with the performance of the production equipment and the product produced should be used.

The next step is to run the machine that will produce the product at different production speeds using the tray or box designs as shown in the "FEFCO technical specifications for converting equipment".

The speeds at which tests are conducted as a percentage of the maximum design speed quoted by the machine supplier are:

- 90%
- 70%
- 50%

Smaller speed intervals can be used for the test but will increase the number of tests.

At least 1,000 products should be produced for each test. For every 100 products one sample should be taken for evaluation. These samples can also be used in tests where normally consecutively produced samples are used for evaluation.

The produced products are evaluated according to the defined properties.

The maximum speed at which a machine can produce a good product is the speed at which all agreed properties pass the agreed target level.

The maximum speed a machine can produce a good product is influenced by:

- outer liner
- board grade
- tools (printing die, cutting die)
- raw materials (ink, glue etc.)
- use of auxiliary equipment (e.g. dryers when printing).

5. Results reporting

The results are reported in a Pass/Fail table as follows:

Speed	Property 1	Property 2	Property 3	Property 4	Property n
100%	Fail	Fail	Pass	Fail	Fail
90%	Pass	Fail	Pass	Fail	Pass
80%	Pass	Pass	Pass	Fail	Pass
70%	Pass	Pass	Pass	Pass	Pass
60%	Pass	Pass	Pass	Pass	Pass
50%	Pass	Pass	Pass	Pass	Pass

In the above table the maximum machine speed producing a good product is 70% of the maximum machine design speed.

6. Target

Target levels are always agreed between customer and supplier.

The following is the proposed target maximum speed at which a machine produces good product values in function of the outer liner and board grade:

	B flute	EB flute
Uncoated outer liner	90%	80%
Coated outer liner	70%	60%

References:

- 1) FEFCO technical specifications for converting equipment, technical specifications for equipment and process

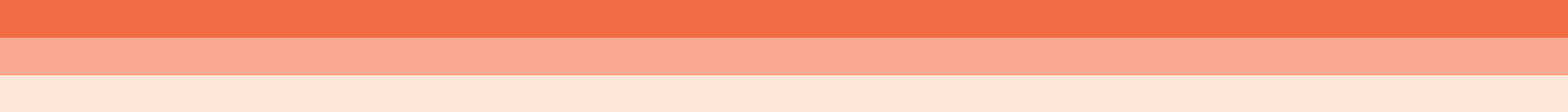

TEST FORMS FOR FEFCO CONVERSION MACHINE TECHNICAL SPECIFICATIONS



1. Test form: Printing Only



Used in TS: 0201, 0302, 0303, 0304, 0309, 0310, 0312, 0313, 0316, 320

2. Test form: Printing & Flat Bed Die Cutting

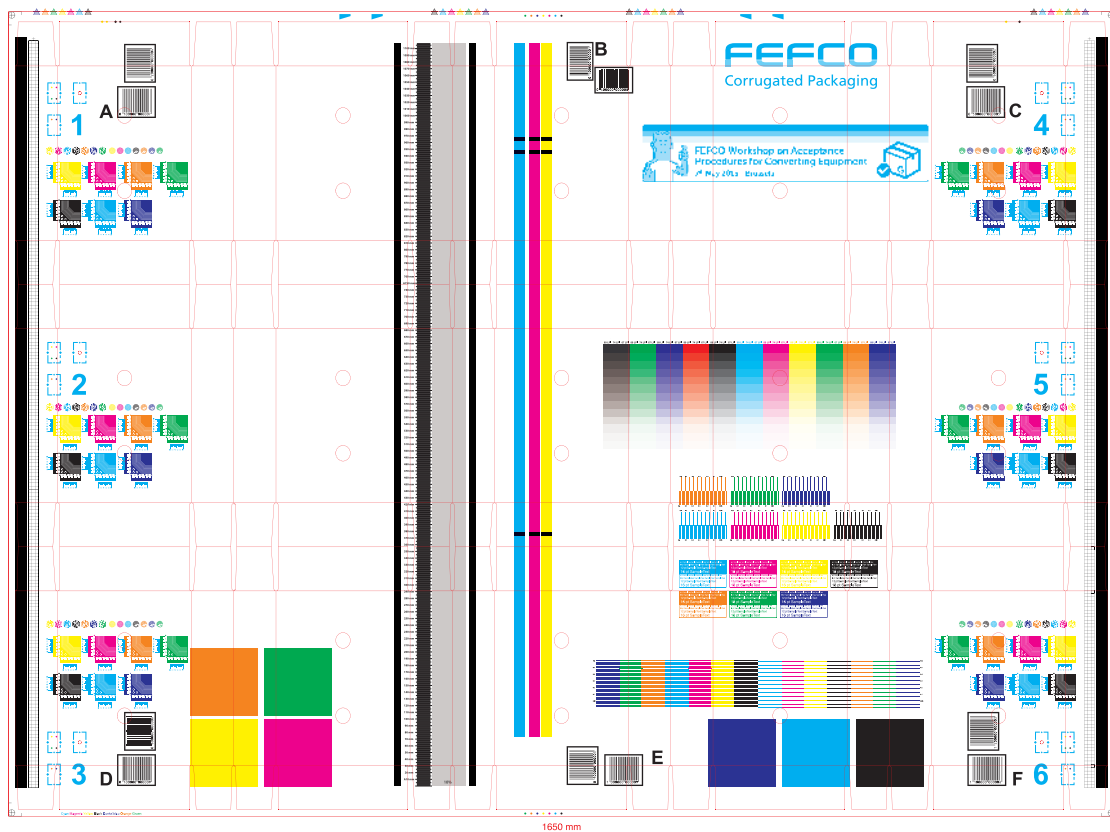

Used in TS: 0201, 0302, 0303, 0304, 0309, 0310, 0312, 0313, 0316, 320, 0601, 0602, 0603, 0604, 0704, 1001, 1002, 1102

3. Test Form: Printing & Rotary Die Cutting

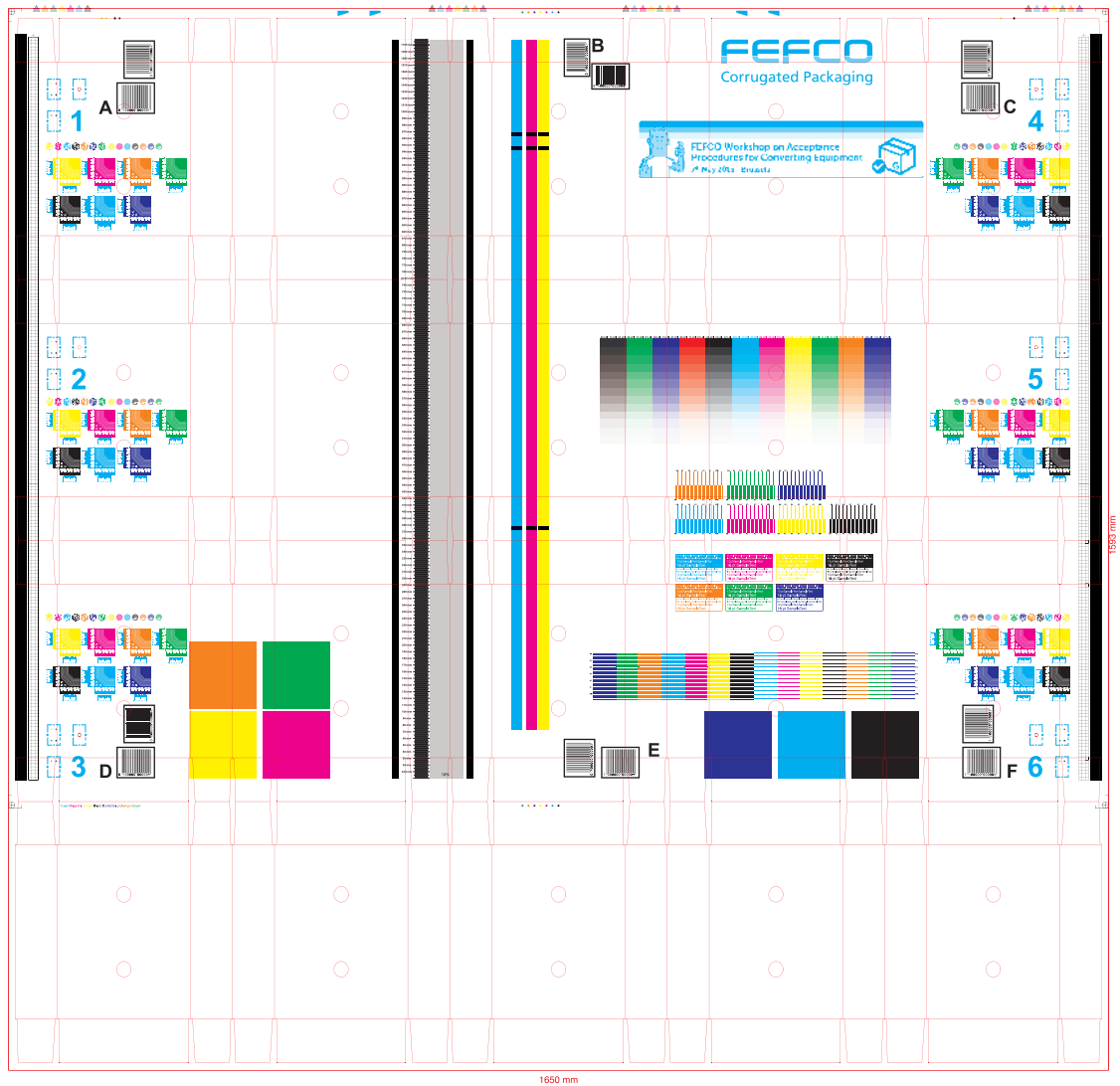

Used in TS: 0201, 0302, 0303, 0304, 0309, 0310, 0312, 0313, 0316, 320, 0601, 0602, 0603, 0604, 0704, 1001, 1002, 1102

4. Test Form: Normal Size Flexo Folder Gluer

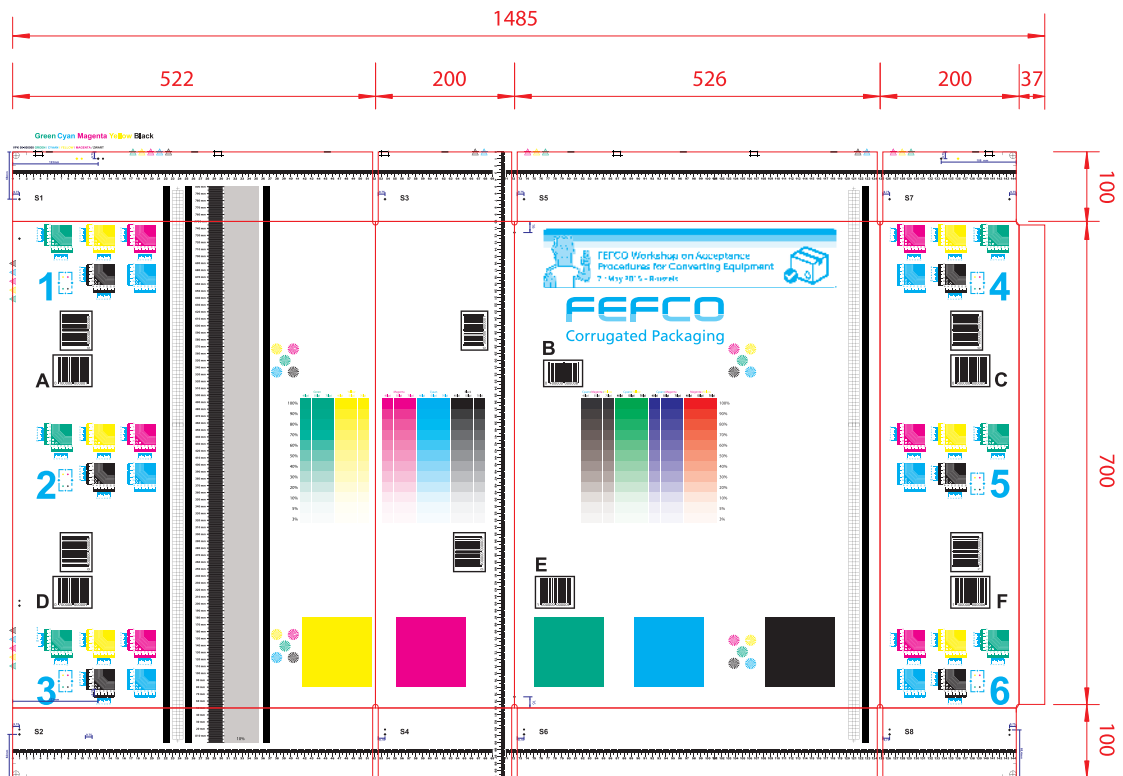

Used in TS: 0201, 0302, 0303, 0304, 0309, 0312, 0313, 0316, 0501, 0502, 0701, 0702, 0704, 0705, 0706, 0901, 1101, 1102

5. Test Form: Small Size Flexo Folder Gluer

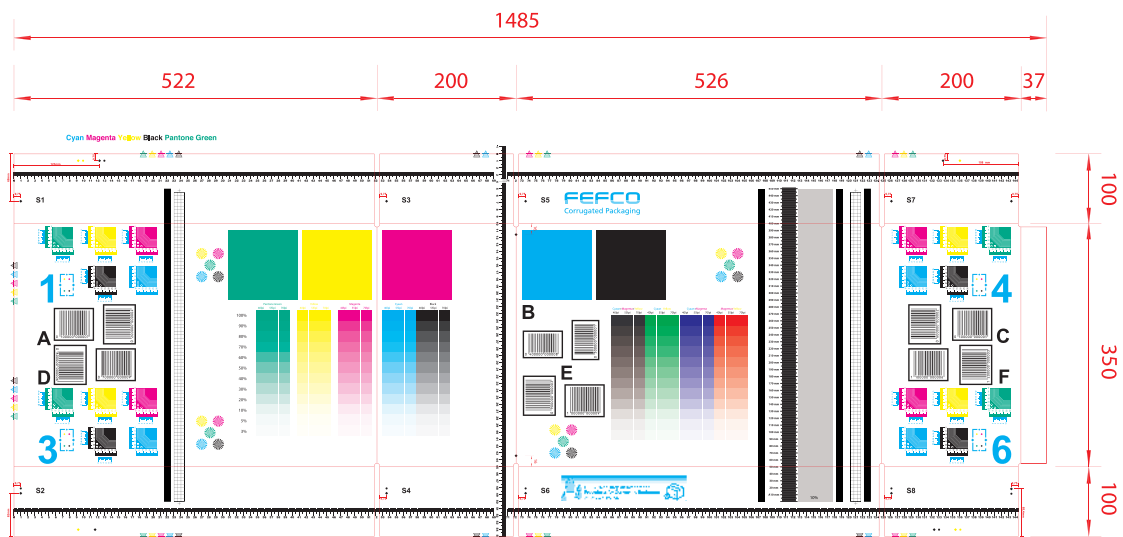

Used in TS: 0201, 0302, 0303, 0304, 0309, 0312, 0313, 0316, 0501, 0502, 0701, 0702, 0704, 0705, 0706, 0901, 1101, 1102

CONVERSION EQUIPMENT GLOSSARY



This document provides a glossary or explanation for the elements that can be tested during conversion equipment acceptance procedures used in the corrugated industry. Some of these procedures are generic and can be used for equipment in other processes with the same function (e.g. printing).

A technical specification has been written for each element of the acceptance procedure. These individual standards describe the elements and properties evaluated and which units to use to quantify the result of the evaluation.

The elements described in the specifications stand on their own. A company which is busy with designing an acceptance procedure for new, re-built or recently serviced conversion equipment can select the elements it would like to test during acceptance of the equipment.

The reasoning in this document will help all parties in discussions as to why the individual elements in an acceptance procedure should be used.

Corrugated board conversion equipment is divided into the following parts:

- pre-feeding
- feeding
- printing
- screen roll
- slotter/scorer
- die cutting
- folding
- stacking
- bundling
- breaking
- palletising

The screen roll is a part used in the flexo printing process. This part is described separately as it can be purchased as a spare part.

For each conversion machine part, elements are identified that can be checked during acceptance.

1. Pre-feeding

The pre-feeder is the section in corrugated conversion equipment that accepts complete pallets of corrugated board and then separates the board into single sheets and fills the feeder of the machine. It has a board buffer allowing time for the removal of an empty pallet and the loading of a new pallet.

The elements identified for testing during acceptance are the following:

- stops/1000 sheets sample warp
- time between stops when running auto
- waste sheets.

101 Stops/1000 sheets

The first step is that the warp of the board used for the test is measured. The warp of the board needs to be below a given level. The test can be conducted during the standard production of a large order, preferably a minimum of 5,000 sheets.

The number of stops is counted during the conversion of the board. For each stop the reasoning is logged, for example, the removal of an empty pallet.

It is important that the pre-feeder does not cause stops in production.

102 Time between stops when running auto

The data collected in 0101 also allows the calculation of the time between stops. It is important to note that this should be done when the pre-feeder is set to auto production mode. A histogram of the time between stops for a given production order run length in sheets is shown rather than statistics.

It is important to understand when stops occur in order to analyse the common possible causes of the stops.

103 Waste sheets

During production the number of waste sheets removed at the pre-feeder is recorded.

The minimum production order length is 5,000 sheets. A value is calculated for the number of waste sheets per 1,000 sheets converted.

It is important to understand the relative pre-feeder waste.

2. Feeding

The feeder times the introduction of the sheets and accelerates the sheet from zero up to production speed.

The feeding of the board dictates to a large extent how the product comes out at the end. The correction of a feed error during production can be regarded as virtually impossible.

The element identified for testing during acceptance is:

- feed to first register PD/CPD variation.

201 Feed to first register PD/CPD variation

The register in production direction (PD) between the lead edge of the board and the lead edge of the print is measured for a feeder. This is on the operator side (OS) and drive side (DS) of the production equipment.

In the same way the register in cross production direction (CPD) between the side of the board and the side of the print can be measured. This is on the lead edge and trail edge.

The variation is calculated as the standard deviation of all feed distance errors.

This test shows the position of the print relative to the sides of the sheet. It will help understanding of how sheets travel through the production equipment. This is also important for the evaluation of folding and/or offline die cutting.

3. Printing

The print station transfers to the substrate a single colour separated from the original image.

It is important that the individual print stations transfer their part of the separated image to the substrate in sequence, and that the transfer is uniform (equal pressure) during every print repeat.

The elements identified for testing during acceptance are the following:

- TIR (screen roll, plate cylinder, impression cylinder)
- colour to colour register variation
- colour variation
- colour change during start-up
- ink consumption
- ink loss during colour change
- water addition during colour change
- ink system cleanliness after wash-up
- gap (barcode width variation)
- ghosting
- stripes in print (encoder test)
- filling between dots
- print scuff (drying)
- gloss level

301 TIR (screen roll, plate cylinder, impression cylinder)

TIR stands for total indicated run-out. Run-out is an inaccuracy in rotating mechanical systems or more specifically, that the tool or shaft does not rotate exactly in line with the main axis. This value is measured for all key cylinders rotating in the conversion equipment print stations.

The TIR of cylinders has an impact on the gap variation between cylinders affecting the uniformity of the pressure during a revolution. Non-uniformity will affect the print, such as print register and dot gain.

302 Colour to colour register variation

Colour to colour registration error is the distance between the printed positions of two separately printed elements that had the same position originally.

The variation is calculated as the standard deviation of all measured register distance errors.

It is important to know how much the printed position of a print station deviates from the target position as the register error has an impact on the perception of the printed image. For example, an observer can perceive an image as blurred due to a register error.

303 Colour variation

Colour error is the difference in the colour space between the printed colour and the target colour. For colour variation the target colour is the average colour calculated from all colour measurement parts of the sample. The target colour can be regarded as the centre point of all colour measurements.

The variation is calculated as the standard deviation of all measured colour difference errors.

The colour variation of a printing process is the starting point for setting a realistic tolerance. It also provides information about the uniformity of the ink transfer which can be influenced by factors such as the screen roll (engraving), print plate, ink and substrate.

304 Colour change during start-up

Colour change during start-up is the deviation of the colour from the target colour during start-up of the printing process. The target colour is set as the average colour measured from, for example, sheets 21 to 30 after hitting the start button.

The number of sheets which have a higher deviation from the pre-set value for the maximum deviation allowed is counted.

This is measured as it is important to know how many products need to be rejected because of a too high colour deviation before a product is made which passes the quality criteria.

305 Ink consumption

Ink consumption is expressed as the ink film thickness transferred from the screen roll by the print plate to the substrate.

The value can be expressed as an absolute value in μm when printing a full tone area.

Ink consumption is an important value as it identifies if screen rolls, ink and print plates perform according to pre-set targets. Note that all factors influencing ink consumption need to be defined and specified for the test. For example, the water content of water based ink and the coverage of a print plate (dot size/line count).

306 Ink loss during colour change

Ink loss during colour change is the amount of ink that is lost when changing colour on a print station. This is all the ink that is not returned to the ink bucket after filling and emptying the print station. Note that ink loss is complicated to measure as the returned ink may be contaminated by residual water in the print station.

This test is important for reducing the environmental impact of the machine and to estimate the relation between ink consumption used for printing on the substrate and total ink consumption.

307 Water addition during colour change

Water addition during colour change is the water that gets added to the ink during a colour change as the ink system might still hold residual water after washing.

The residual water left after washing the print station has a negative impact on the actual measured ink loss and the printing of the first sheet in the right colour as it contaminates the ink formulation. It also has a negative impact on the ink returned from the press.

308 Ink system cleanliness after wash-up

It is important that the ink system is clean after wash-up. This means that no ink from the previous order is left in the ink system before inking up again. Ink system cleanliness is measured as a contamination of varnish, which is ink that does not contain any pigments.

The new ink might be contaminated by old ink if ink from a previous order is left in the ink system. This might result in a colour deviation at start-up depending on the printed colour and the previous colour.

309 Gap (barcode bar width variation)

The uniformity of the pressure settings during printing is measured.

The uniformity of the pressure depends on the alignment of the cylinders in the print stations.

This can be checked using the following two methods:

1. Measuring the uniformity of the gap across the width of the machine between the cylinders
2. Printing identical barcodes over the width of the machine and measuring the bar width gain.

310 Ghosting

There are different causes of ghosting or duplication of an image. During acceptance it has to be checked that ink is not transferred back to the screen roll from the printing.

It is important to check this as it will help determine the causes of stripes in printing that are not related to the printing equipment and/or the performance of the dryers.

311 Stripes in print, encoder test

Cross print direction stripes in printing can be linked to gears or the driving of direct drive motors.

The encoder test monitors the uniformity of cylinder rotation using encoders mounted externally on the shafts of the screen roll, plate cylinder and impression cylinder.

The external and independent monitoring of the uniform rotation of cylinders in conversion equipment helps determine if drive systems are the cause of cross print direction stripes in print.

312 Filling between dots

The filling between dots is evaluated on printed halftone areas depending on dot size and line count.

The filling between dots provides information on the effect of the amount of ink transferred on the printed dot size depending on the substrate used for the test.

313 Print scuff (Drying)

Print scuff is the scuffing of ink printed as a single layer or as multiple layers on top of each other.

Ink scuffing can be linked to ink properties and/or dryer performance. It also shows if the printed area is being touched during the transfer of sheets through the conversion equipment.

314 Gloss level

Gloss level is measured depending on the substrate used and the lacquer applied.

Measuring gloss levels identifies if the screen roll installed for printing lacquer transfers sufficient lacquer.

315 Stripes in print, bouncing test

Cross print direction stripes in printing can be linked to gears or the driving of direct drive motors.

The bouncing test monitors cylinder deflection during one print revolution and the resulting gap deviations between screen roll and plate cylinder, plate cylinder and impression cylinder of screen roll, plate cylinder and impression cylinder.

The bouncing test shows if a cross print direction stripe occurs in terms of colour difference between centre and lead edge/trail edge. It will show if cylinder deflection is the cause of stripes in print.

316 Colour to colour register change during start-up

Colour to colour registration error is the distance between the printed positions of two separately printed elements that had the same position originally.

The colour to colour register change during start-up will show the influence of an empty transport system at the beginning of production compared with a transport system that is holding board.

It is important to know how much the printed position of a print station deviates from the target position as the register error has an impact on the perception of the printed image. An observer can perceive an image as blurred due to a register error.

Colour to colour register change during start-up of the print process is the deviation of the colour to colour register from the target colour to colour register. The target colour to colour register is set as the average colour to colour register measured from, for example, sheets 21 to 30 after hitting the start button.

The number of sheets having a higher colour to colour register deviation than the pre-set value for the maximum deviation allowed is counted.

This is measured as it is important to know how many products need to be rejected because of a too high register deviation before a product is made which passes the quality criteria.

4. Screen roll (anilox roll)

The screen roll (anilox roll) is the part of the print unit responsible for regulating the amount of ink film available for transferral to the substrate by the print plate.

The elements identified for testing during acceptance are:

- wet ink film thickness
- line count
- cell wall thickness.

401 Wet ink film thickness

The wet ink film thickness (IFT) is the thickness of the ink film available on the surface of the screen roll ready for transferral to the substrate via the print plate.

The wet ink film thickness available on the surface of the screen roll is a measure of what can potentially be transferred. The value in combination with the actual ink transfer measured (TS0305) will allow the calculation of the relative ink transfer from the screen roll to the substrate.

A low relative ink transfer indicates that screen rolls might get dirty more quickly and thus need more frequent cleaning.

402 Line count

The line count is the number of cells measured over a linear distance. The line count on a screen roll is an indicator of how likely the screen roll will transfer the wet ink film available on the surface.

High line count screen rolls compared to low line count screen rolls will transfer less of the available ink on the surface of that screen roll if both the high and low line count screen rolls have the same ink film thickness available for transferral.

403 Cell wall thickness

The cell wall thickness is the thickness of the cell walls between the cells holding the ink on the surface of the screen roll.

The cell wall increases during the lifetime of the screen roll and is thus an indicator of the state of the screen roll in terms of wear and tear.

Screen rolls with the same ink film thickness on the surface and same line count will have a different ink transfer characteristic depending on the cell wall thickness. The screen roll with wide cell walls will transfer less of the available ink on the surface. It will usually have deeper cells.

5. Slotter/scorer

The slotter/scorer cuts slots in the sheet which creates the flaps of the box. The scorer scores the panels so that the box can be assembled by folding over the score lines.

The elements identified for testing during acceptance are:

- slot position relative to centre line
- slotting depth variation on centre score.

501 Slot position relative to centre line

The accuracy of all the slot heads' positions relative to the centre slot is measured. The positioning of the slot heads relative to the centre slot has a direct impact on the manufacturer's joint gap. Slot head position can also be a cause of fishtailing or panel misalignment, especially when slot heads are positioned on different axis for lead edge and trail edge slotting.

502 Slotting depth variation on centre score

The slotting depth of the centre slot is measured on the lead edge and trail edge. Slotting depth is an important value to check for the setting accuracy of the machine.

6. Die cutting

The die cutter cuts and scores the sheet so that a box or tray can be folded. The elements identified for testing during acceptance are:

- print to die cut register variation
- scoring depth variation
- tray length variation
- waste removal

601 Print to die cut register variation

Print to die cut registration error is the distance between the print and die cut positions of two separate elements that had the same position originally. The variation is calculated as the standard deviation of all measured register distance errors. It is important to know how much the positions of print and die cut tools deviate from the target position to avoid barcodes ending up in a place where they cannot be scanned or print is cut off as waste. The data will also provide information on whether print and die cut tools have the same dimensions.

602 Scoring depth variation

Scoring depth is the depth of the score lines in the die cut product. The score depth needs to be uniform over the full sheet. Score depth evaluation provides information about the gap setting between die cut tool and anvil. The same measuring method can be applied to rotary and flatbed die cutting.

603 Tray length variation

Tray length variation is the variation in length of the same trays that are repeated over the width and height of the sheet. Tray length variation is measured in production direction. The tray length variation provides information about the uniformity of die cutting in production direction. This uniformity is influenced by the uniformity in the diameter of the anvil and the speed differential between the anvil and cutting tool. The same measuring method can be applied to rotary and flatbed die cutting.

604 Waste removal

Waste removal is a relative value for the amount of waste found between stacked ready products. Waste particles are weighted relative to the weight of the waste particles in the design for a given number of sheets. Die cut waste between products is a problem for customers in their assembly and packing lines.

7. Folding

The folding section is positioned after the slotter/scorer section. It puts glue on the glue lash or glue panel after which the panels are folded into a flat box that can be assembled.

The elements identified for testing during acceptance are:

- glue consumption
- fish tailing
- gap variation
- folding torque in relation to depth.

701 Glue consumption

Glue consumption is the amount of glue consumed per product produced. Glue consumption or the application of glue per product needs to be constant and independent of machine speed. The test shows if the glue system is working according to specification.

702 Fishtailing and Gap variation

Fishtailing or panel alignment is the cross production direction alignment of the panels at the manufacturer's joint.

It is measured on the finished product, after it has passed the squaring unit.

Fishtailing is important in order to produce a box that can be assembled. Fishtailing has a direct impact on box performance.

The lead edge and trail edge cross production direction gap is measured at the manufacturer's joint. It is measured on the finished product after it has passed the squaring unit.

Gap variation is important in order to produce a box that can be assembled. Gap variation has a direct impact on box performance.

704 Folding torque in relation to scoring depth

Folding torque is a measurement of how much torque is required to fold the flaps on a box.

It is measured on the finished product.

Folding torque is important in order to produce a box that can be assembled.

Folding torque needs to be measured as part of an acceptance test depending on when the score is applied. If the score is applied at the corrugator then the flap folding torque is not directly linked to the performance of the conversion machine. The flap score line can also be introduced by a tool on the conversion machine. In this case it is linked to the performance of the conversion machine.

705 Number of stitches

The number of stitches is a measurement on a stitcher and indicates the number of stitches per linear metre applied. It also checks if the same number of stitches are applied to individual products.

The number of stitches are manually counted on the finished product.

It is important to measure the number of stitches per box in order to confirm uniformity of box strength.

706 Tape consumption

Tape consumption is a measurement of the ratio between tape length and lash length. This is an average value for a series of boxes produced.

Tape consumption is measured in tape reel weight difference before and after the production of boxes.

It is important to measure tape consumption in order to confirm uniformity of box strength.

8. Stacking

Stacking is the section where sheets accumulate either in bundles or as sheets directly on the pallet.

The elements identified for testing during acceptance are:

- alignment
- stops/1000 sheets
- exact sheet count.

801 Alignment

The test can be conducted during the standard production of a large order, preferably a minimum of 10 pallets.

The alignment of sheets or bundles on the pallet is measured. This can be done by placing a straight bar against the pallet and measuring the gap between the sheets and the bar. This should be done at the four corners of the pallet. The maximum gap measured is a value for the stack alignment.

Bundles and sheets on a pallet need to be straight and square to avoid product damage, to maximise space utilisation on a truck during transport and to prevent the pallet from falling over.

802 Stops/1000 sheets

This test can be conducted during the standard production of a large order of preferably a minimum of 5,000 sheets.

The number of stops is counted during the conversion of the board. For each stop the reasoning is logged.

It is important that the stacker does not cause stops in production.

803 Exact sheet count

The number of sheets per pallet or sheets per bundle (FFG) is counted and compared with the pre-set value. The deviation in number of sheets from the pre-set value is recorded.

It is important to supply the customer with exact sheet counts to avoid over or under supply of a product.

9. Bundling

The bundler straps a bundle of boxes to one package.

The elements identified for testing during acceptance are:

- stops/100 bundles.

901 Stops/100 bundles

This test can be conducted during the standard production of a large order of preferably a minimum of 500 bundles.

The number of stops is counted during the bundling. For each stop the reasoning is logged.

It is important that bundling does not cause stops in production.

10. Breaking

The breaker breaks a stack of die cut sheets into individual stacks of, for example, trays.

The elements identified for testing during acceptance are:

- breaking force in relation to bundle height
- breaking cycle time.

1001 Breaking force in relation to bundle height

This tests if the breaker has enough force to break a pre-set stack of die cut sheets for a given board grade and tray design. The number of sheets used for the test is determined by board grade and the maximum stack height the breaker can handle.

It is important that the breaker is strong enough to break the pre-set stack of sheets for the specified board grade and design. This also provides information on the breaker and whether it is able to meet productivity targets.

1002 Breaking cycle time

The cycle time for breaking a bundle of sheets is measured during the breaking force test.

The cycle time is split into:

- the time taken for the bundle of sheets to enter and leave the breaker
- the time taken for the actual breaking of the bundle.

The cycle time needs to be within the pre-set cycle time. It provides information on whether the breaker meets the pre-set productivity target.

11. Palletising

The palletiser puts stacks or bundles on a pallet.

The element identified for testing during acceptance is:

- stops/pallet.

1101 Stops/pallet

The test can be conducted during the standard production of a large order of preferably a minimum of 10 pallets.

The number of stops is counted during palletising. For each stop the reasoning is logged.

It is important that palletising does not cause stops in production.

12. General

The last part is to measure overall machine performance.

1201 OEE (overall equipment effectiveness) performance

Three criteria are used to measure OEE:

1. availability
2. performance
3. quality.

The product of all three individual elements should be above a target of 92%. It will show that the machine uses the available production time efficiently, produces at an acceptable speed and delivers an acceptable product.

13. Conclusion

This document gives a justification as to why tests need to be conducted during the acceptance of conversion equipment.

In the future more tests will probably be added and the document will be updated accordingly.

The customer and supplier agree on which tests they want to be part of the acceptance procedure for the conversion equipment to be tested.

Targets agreed between customer and supplier are always absolute values. A standard deviation cannot be used as a target. The standard deviation is a quantification for the variation of the analysed data. This is a result derived from a test.

A machine meets its target if the standard deviation, which is derived from the measured data times three or six (depending on how the target is defined), is less than the target. It means that 99.7% of the sample evaluated is within the set target.



Layout Simpli.be - Proofreading Susan Wood